

Lightning Protection & Grounding Solutions for Communication Sites

FIRST EDITION

Ken R. Rand

© 2000 by **PolyPhaser**[®]

All rights reserved. No part of this publication may be reproduced or transmitted in any form or by any means, electronic or mechanical, including photocopying, recording, or any information storage and retrieval system, without permission in writing from the publisher.

First Printing 2000

Printed in the United States of America

Introduction

This publication was compiled from the original book *The "Grounds" for Lightning and EMP Protection* by Roger R. Block, co-founder of PolyPhaser Corporation, and additional articles written by Roger and myself over the last several years. I have brought in some up-to-date information during the re-write. Some text has been revised and re-ordered for logical sequence and clarity.

The lightning protection industry owes a great deal to Roger for an innovative lightning protector product line, site protection techniques, and his informal way of pointing out problems. Although seldom appreciated by traditionalists and the academia, his research and practical conclusions were "right on" for our emerging industry. The following chapters continue in that tradition.

Thanks to all who participated in this latest effort and an honorable mention for Bogdan (Bogey) Klobassa who contributed to Chapter 7 and never tires of talking about lightning protection.

*"Let us hope this book, as with our knowledge, will never have an end, for we are just beginning to learn and understand."*¹

Ken Rand
January 2000

¹ Quote from Roger Block, who is now happily flying his airplane, inventing something, or reluctantly playing golf.

Table of Contents

1	The Lightning “Event”	1
2	Tower Strikes & Solutions	11
3	Grounding & Materials	27
4	Ground Impedance	39
5	Tower Top, Pole-Mounted & High-Rise Communication Sites	43
6	Coaxial Cable Lightning Protectors	47
7	ac and dc Power Protection at Communication Sites	55
8	Telephone Network & Computer Interfaces at Communication Sites	65
9	Protecting Equipment from NEMP Damage	69
10	Security Cameras, CATV, GPS & Satellite Protection	71
11	Appendix	77
	Lightning Protection Myths and Traditions	79
	Tables and Formulas	83
	Definition of Terms	85
	Bibliography	88

The Lightning “Event”

There are volumes of information available on what we believe lightning is and how we think it works, most of it beyond the scope of this modest textbook. We will indulge in a form of pragmatism focusing on a practical approach to equipment protection at a communications site during a lightning “event.” The science of grounding (earthing) for lightning events encompasses both the laws of physics and RF design.

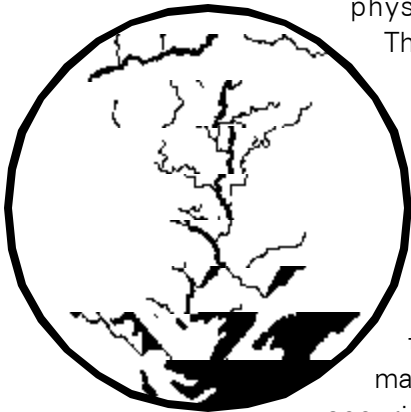

Throughout this textbook are proven concepts, which will protect your valuable equipment from direct or induced lightning damage. Whether your equipment is at radio site, pipe line, utility sub-station, telephone central office, maritime, military, or sensitive security installation, the same requirements apply for protection devices, proper device placement, and earth grounding.

THE STEPPED LEADER AND THE UPWARD GOING STREAMER

As the electrically active cloud stratifies its charge in preparation for a cloud to ground strike, it produces an opposite polarity “mirror image” area in the earth directly below. Most cloud to earth strikes are negative (electron flow downward), some are positive, and an occasional event is bi-polar. Positive strikes are usually more severe and have been associated with cyclone activity (tornadoes/hurricanes). *To keep things consistent throughout this book we will be using negative strikes in our examples.*

As the “E” Field (voltage) builds in potential between the charge center in the cloud and

earth, it reaches a state where the atmosphere begins to break down and a “stepped leader” from the cloud tentatively reaches out and down towards the earth. Although the stepped leader is almost invisible, it is forming the beginnings of an ionized path that the strike(s) will follow on its way to an upward going streamer (also known as a “return stroke”) or direct earth contact. The stepped leader jumping distance is determined by the charge in the cloud. The smaller the charge, the smaller the jump. A typical jump (96%) is 150 feet or greater. The stepped leader will move this distance in 1 microsecond, pause for 49 microseconds, and then make another jump.

As the end of the stepped leader (which has the same potential as the charge center in the cloud) approaches the earth, the “E” Field gradient between the end of the step leader and any high “earthed” conductor (trees, towers, “lightning rods!”) exceeds the breakdown of the atmosphere around the “earthed” conductors. A corona forms around the part of the conductor closest to the incoming stepped leader. If the stepped leader approaches closer, the corona grows in to what we call an “upward going streamer” representing the opposite charge in the earth. This streamer can reach out 15 to 20 feet in an attempt to join with the stepped leader to form a conductive path for the main series of strikes to follow.

Once the stepped leader and streamer are joined, large currents will flow as a consequence of the high potentials involved. The amount of current flow in each stroke is determined by the ability of the cloud to migrate more electrons to the discharge point, and the overall inductance of the ionized path and struck object. This entire discussion is applicable only until a newer and better theory comes along!

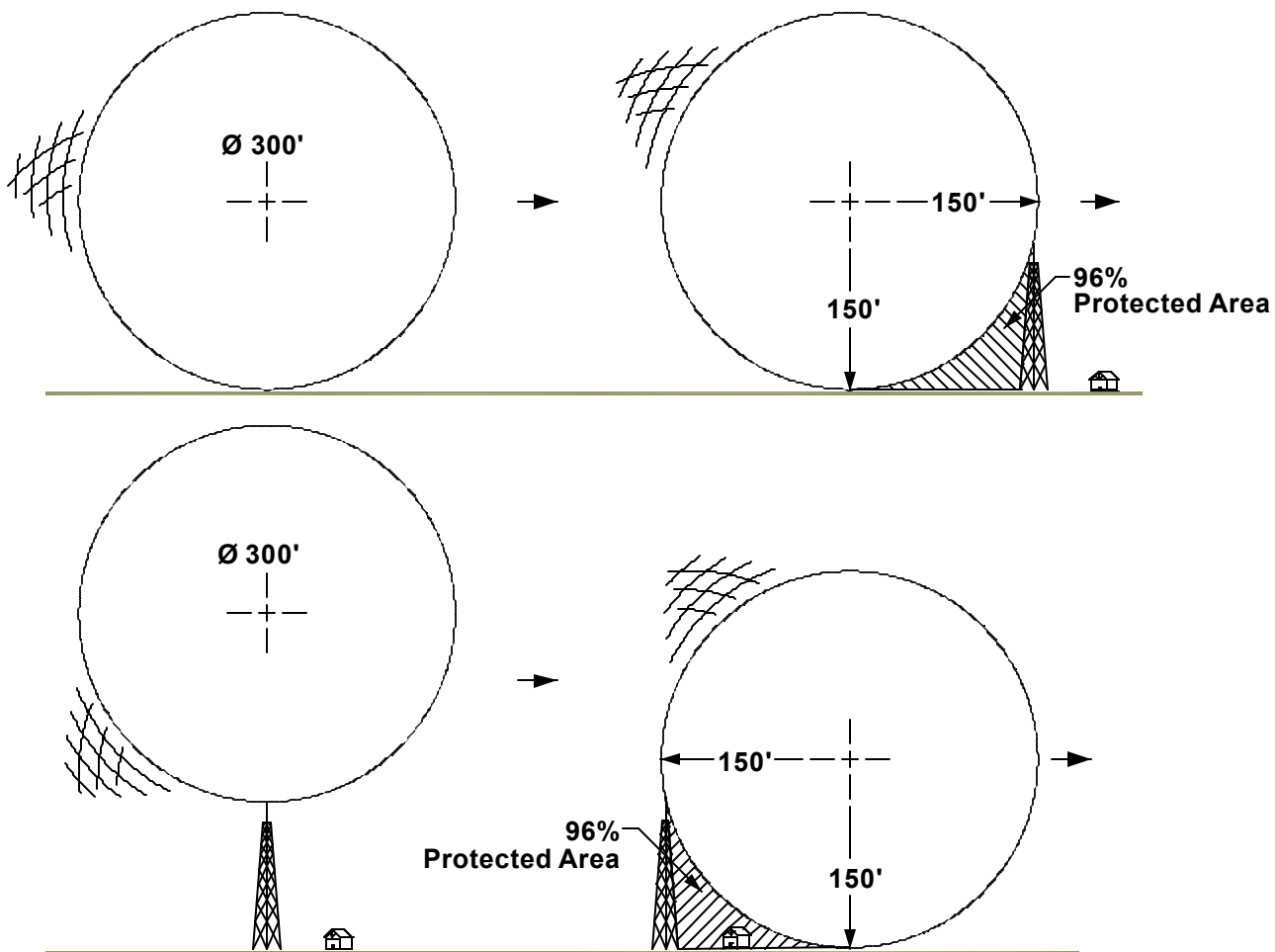

STEP LEADER IMPLICATIONS

The "Rolling Ball" Theory

If the tower is over 150 feet tall, side-mounted antennas are vulnerable to direct hits. Since 1980, the NFPA (National Fire Protection Association) has been advocating in their Lightning Protection Code NFPA #780, that a 45-degree cone angle from the top of the tower towards the earth does not describe an effective protection area.

Visualize a tower site, and imagine a 150-foot radius sphere (representing a step leader typical jump) rolling over all outlined objects, everywhere the sphere touches could be hit by lightning. The sphere must be "rolled" for each compass line since we are dealing with a three dimensional image. When the sphere bridges between two points, the area beneath the sphere is a 96% protected zone.

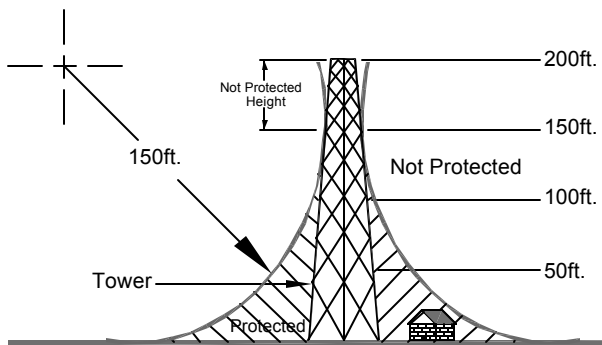

As the sphere rolls up the tower, it will begin to touch side mounted antennas above the 150-foot mark. For guyed towers, the sphere will need to be rolled not only for each compass line around the tower base, but also around each compass line for each guy anchor point. The mesh that is created will cover the tower like canvas on a circus tent. The area above the tent is unprotected and the area below is the protected area.

Side-mounted antennas near the top, or in sections not covered (protected) by the guy wires, can be hit. One way to protect these antennas is to install two or more horizontally mounted "lightning rods" attached to the tower just above and below the antenna. As the 150-foot radius sphere rolls on the tower, the length of the horizontally mounted rods protrude outward from the tower so the sphere does not touch the antenna.

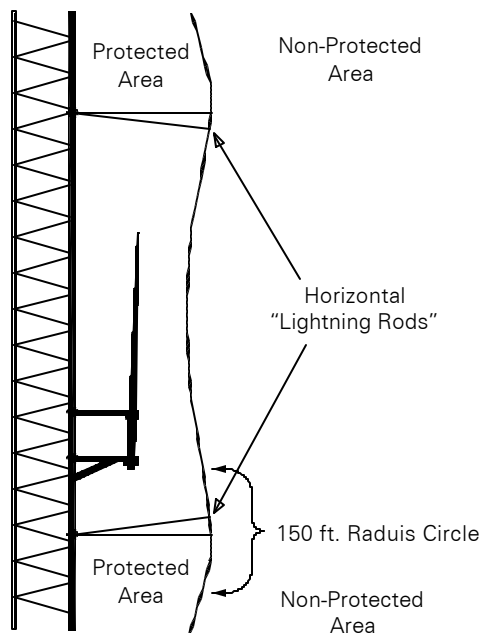

For a 20-foot long antenna, side-mounted above the 150-foot height, the horizontal rod(s) should protrude a *minimum* of 6 inches beyond the antenna. This will give a 96% degree of protection from direct strikes to the side-mounted antenna. Since diverter rods are horizontal and are located in the end nulls of the antenna pattern, no changes will be made in the systems performance.

The rolling ball concept is based on the step leader jumping distance. The larger the charge in the cloud, the larger the jumping distance. The smaller the charge, the smaller the distance. This is why the percentage of protection for the zone (96%) is not 100%. Theoretically a small step leader could penetrate the zone, but it would be a small strike with little damage capability.

A tall tower, above the 150 foot point, should have coax cable grounding kits spaced so a side strike to the tower will not have to go far before a bond between the tower and transmission line(s) occur. This will help prevent side flashes, which could produce water invading pin holes in lines. A recommendation is for 75' to no more than 100' separation between grounding kits above the 150' point- unless the rolling ball concept shows guy line protection.

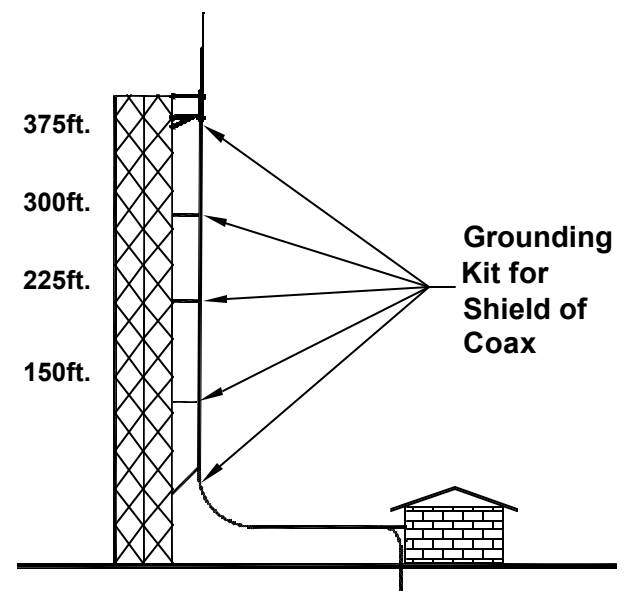

STROKES AND STRIKES

One IEEE Standard is an 8/20 μ s, 3kA current waveshape for lightning (see Chapter 7 for waveshape and discussion). This is the waveshape expected to occur at the equipment after the series inductance of the tower and interconnecting conductors rolls off the fast rise time (conserving some of the rise time energy in the resulting magnetic field), and reinserts the conserved energy at the end of the stroke, affecting the pulse decay time. This standard was originally for ac power applications and has been carried over to coaxial cable entry expectations. With today's heavily loaded towers and multiple coax runs to the equipment, one can expect a much faster rise time and larger current flows.

Lightning typically takes the form of a current pulse with a very fast rise time. Recent studies have shown that lightning pulse parameters can vary geographically. The measurement test setup and the inductance of the struck conductor can also affect results. The pulse statistics in this book are for illustrative purposes showing the kinds of pulses that could occur and were taken from a series of measurements done in the U.S. during the 1970's.

A typical strike (in this series of measurements) could have a 2 μ s rise time to 90% of peak current and a 10 - 45 μ s decay to 50% of peak current. The peak current will average 18kA for the first impulse (stroke) and less (about half) for the second and third impulses. Three strokes is the average per lightning event.

DISTRIBUTION OF TIME TO PEAK CURRENT

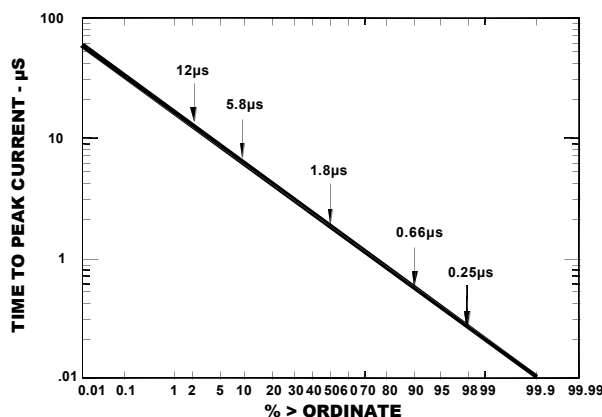

DISTRIBUTION OF TIME TO HALF CURRENT

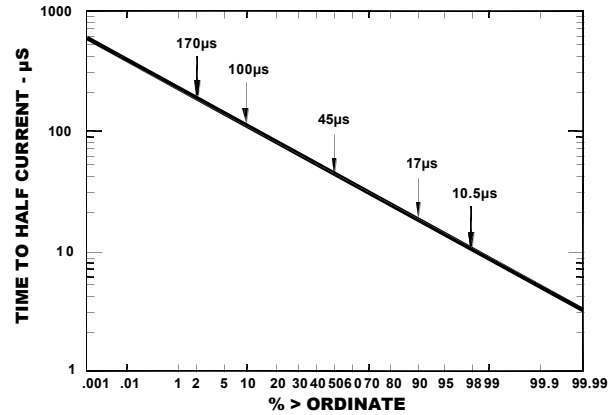

DISTRIBUTION OF STROKE CURRENT - kA

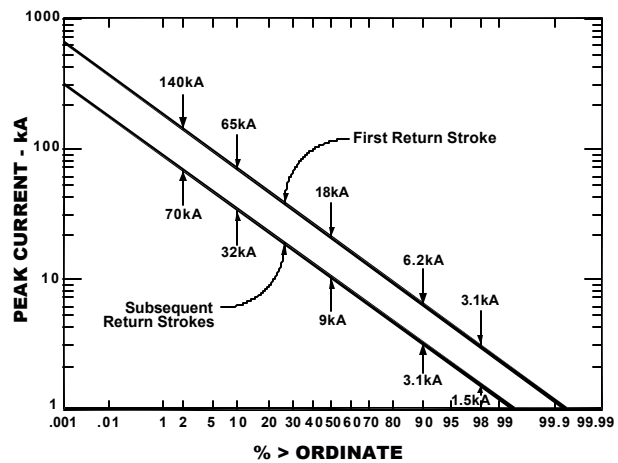

A strike is a constant current source. Once ionization occurs, the air becomes a conductive plasma reaching 60,000 degrees F and is luminous. This luminosity level is brighter than the surface of the sun! The resistance of a struck object is of small consequence, except for the power dissipation on that object ($I^2 \times R$). Fifty percent of all strikes will have a first strike of at least 18kA, ten percent will exceed a 65kA level and only one percent will have over 140kA. The largest strike ever recorded was almost 400kA.

DISTRIBUTION OF THE NUMBER OF RETURN STROKES/FLASH

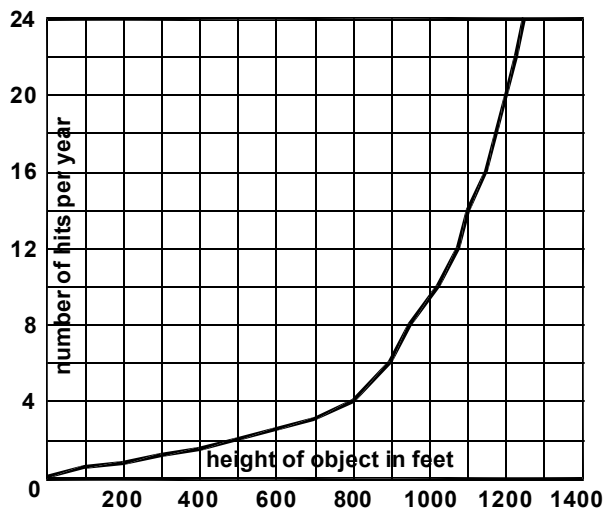
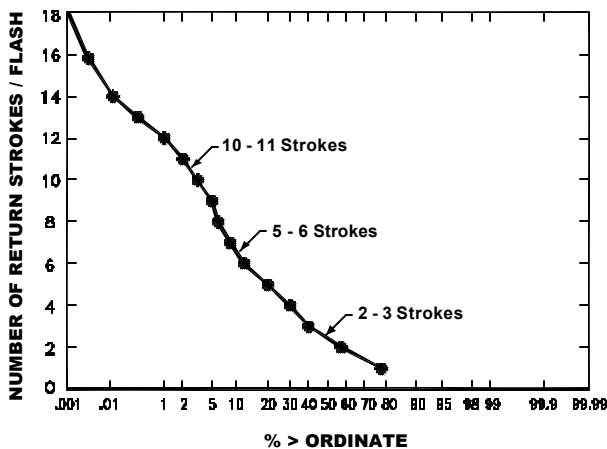

Chart shows susceptibility versus height based on Westinghouse data.

WHY TOWER SITES ARE DAMAGED

Tower sites are struck by lightning more often than any other site. The reason is obvious; the tower is higher than the surrounding terrain, and it is a conductor! Tower structures have a certain amount of resistance and inductance per foot. Most people think of resistance when talking about lightning. However, a tower with all of its weight has rather small joint resistance, typically less than .001 ohms. The $E=IR$ drops are considerable when 18kA is traversing, but even larger peak voltages are present during a lightning strike.

Every conductor has inductance. The amount of tower inductance is dependent upon its geometric configuration. The width-to-height ratio will determine the total inductance of a tower. A theoretical self supporting 150 foot tower, with a 35-inch side width, can have an inductance of about $40\mu\text{H}$. This value of inductance can be approximated ($W/H \leq 1\%$) by treating the tower as a 1/4 wave antenna using:

$$\frac{468 \times 10^6}{2 (H \text{ in feet})} = f$$

then the inductance $L = \frac{377}{2\pi f}$

Inductance for either coaxial lines or single conductor grounding wire can be estimated by using the tables below.

Coax Diameter

	1/2"	7/8"	1-1/4"	1-5/8"	2"	3"
100	51.0	48.0	45.7	44.2	43.0	40.4
150	81.0	76.0	72.3	70.0	68.0	64.3
200	111.0	104.0	100.0	97.0	94.2	89.2
300	174.0	164.0	157.3	152.5	148.7	141.2
500	306.0	289.0	277.8	270.0	263.4	251.0

Approximate Inductance in Microhenries for Coaxial Lines

Size and (Diameter)

	(0.46) (0.365) (0.257) (0.162)(0.102)(0.064)								
Strap	6"	3"	1-1/2"	0000	00	#2	#6	#10	#14
5	1.07	1.28	1.49	1.68	1.75	1.86	2.00	2.14	2.28
10	2.56	2.98	3.39	3.78	3.922	4.13	4.40	4.70	4.98
15	4.21	4.83	5.46	6.04	6.25	6.57	7.00	7.42	7.85
20	5.96	6.80	7.63	8.40	8.70	9.10	9.70	10.25	10.81
25	7.78	8.83	9.88	10.85	11.20	11.70	12.44	13.15	13.85
30	9.67	10.93	12.19	13.35	13.78	14.40	15.26	16.11	16.96

Approximate Inductance in Microhenries for Conductors

Consider a 1/2-inch diameter coax running down 135 feet from the top of our theoretical 150 foot tower. It will have an inductance of about 72μH. If the coax shield is grounded at the top, as it should be, and at the 15 foot level of the tower (a location that we shall see is not optimal), then the total inductance of the tower would be:

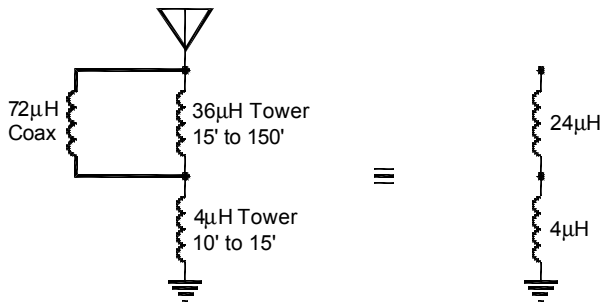

If the coax line is pulled away from the tower at the 15 foot level, traverses 20-feet horizontally to the equipment building and goes to a ground bar having a 6-foot long, #6 ground wire, the total *shield* inductance for this path is 12.7μH. To account for each directional change, one for the coax bend at the tower and one for the ground plate, 1mH was added. This figure is used to facilitate calculations. The real value for a sharp bend is more in the order of 0.15μH and is dependent on the size and shape of the conductor.

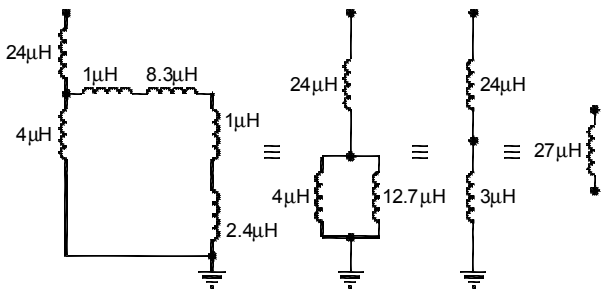

If a perfect conducting ground system (with a non-inductive connection) were present, a 2ms rise time, 18kA, constant current strike, hitting the tower would develop an -L di/dt drop of 243kV between the top of the tower and the bottom. The height at which the lower coaxial cable shield kit is bonded to the tower and pulled away from the tower toward the equipment determines the voltage that is present on the coax shield.

The divided voltage present on the coax shield creates current flow through all the additional paths to ground attached to it.

GUYED TOWERS

We have looked at a self supported tower and can reasonably conclude that, without proper protection and grounding, our equipment will suffer damage.

Looking at the current distribution on a guyed tower, we see the guy wires and grounded guy anchor points perform an important role during a lightning strike.

The same 150 foot tower, with 35" side widths, will be used as the example. The use of 1/2" diameter guy wire with no insulators would look like the following drawing.

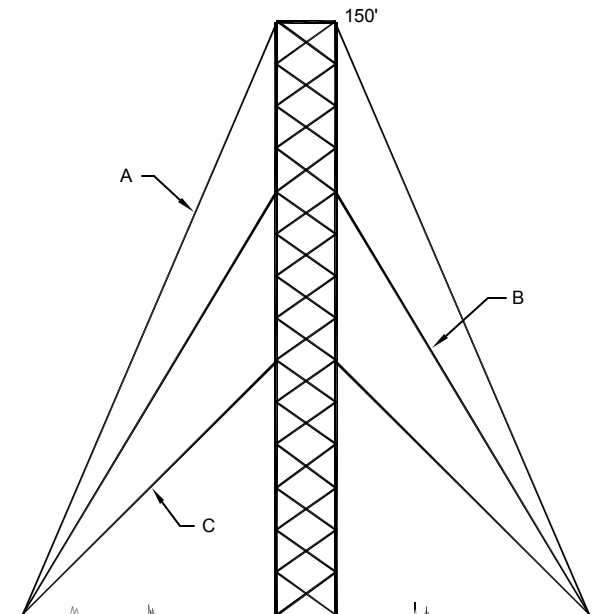

Example	Length in Feet	Inductance in mH	Inductance (mH) for 3 in Parallel
A	180.28	99.00	33.00
B	141.42	75.60	25.20
C	111.80	58.14	19.38

On a triangle base tower, where "A" is approximately 180 feet long or about 99μH each, there would be 3 "A's" in parallel or 33μH total inductance. This will significantly change some of our L di/dt values! Likewise, the lengths of "B" and "C" would be used to calculate their inductance contributions. The thing to remember is - "B" and "C" touch the main inductor (the tower) at different heights (inductance). These heights must be transformed into their appropriate values of inductance before the values of guy inductances can be combined.

To keep it simple, our guy attach heights are at 150 feet, 100 feet and 50 feet. Our complete structure looks like this:

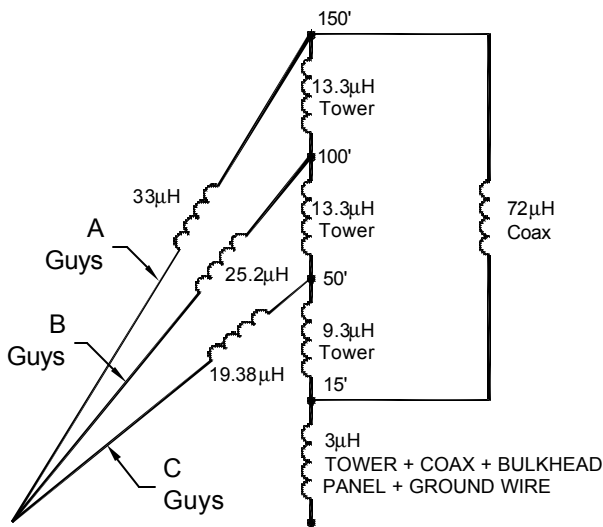

Re-drawing the tower circuit:

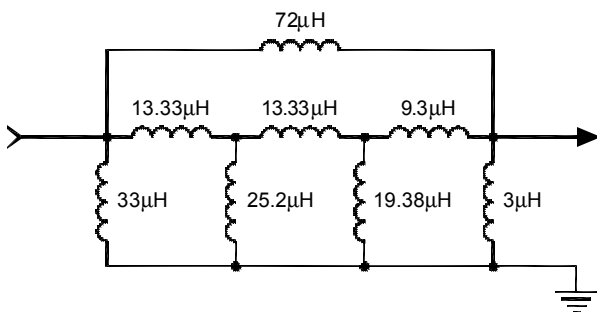

Resulting calculation equals about 12μH top to bottom.

When the 18kA lightning strike occurs, it will have a voltage drop of

$$-E = L \frac{di}{dt} = \frac{12\mu\text{H} \times 18,000}{2\mu\text{s}} = 108\text{kV}$$

from top to bottom ground.

This is less than half of the voltage drop of the self support tower without guys.

The distribution of current on this set-up is a little more complicated. Using mesh current network analysis:

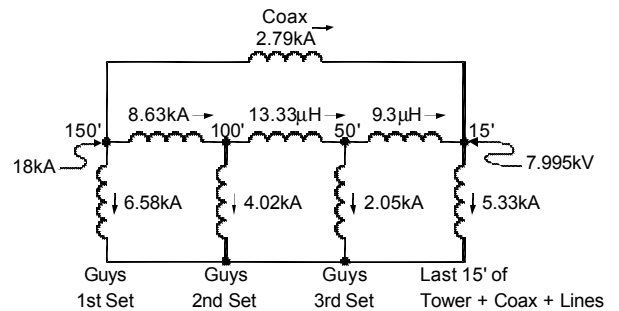

Average Coax Current is 2.79kA

The coaxial cable run to the ground outside bar would have only 1.26kA going to it and would be elevated to 2.14kV. Again, this is far less than the 4.3kA and 7.3kV of the self-support tower!

Before you pull down your self-support tower, remember, in our example we kept the same tower side width of 35 inches and just added guys. A guyed tower might not be this wide, but we wanted to point out the improvement that the guys make by using the same size tower in our calculations.

All of the previous calculations assume the guys are without insulators and the guy anchors are bonded together with the tower leg grounds to form one ground system. If this is not done, the ground resistance/surge impedance at each guy anchor would determine the current distribution.

Now that we have the current distribution, let's see what happens if we ground the coax shield; not only to the bottom and top, but also ground the coax at the guy attachment points on the tower. The new circuit would be:

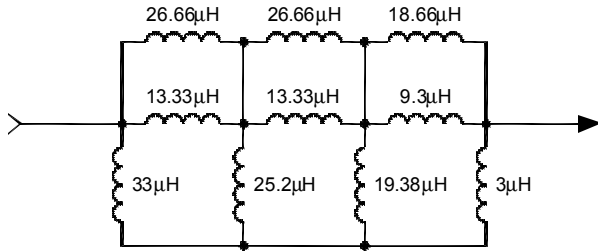

So the total current distribution is:

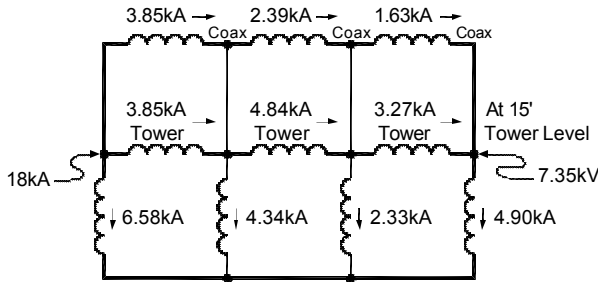

Average Proportional Coax Current is 2.733kA.

Any additional grounding of the coax, say to every tower section, would not provide any benefit for this size tower (150 feet and less). However, it is important to ground the coax lines more often when above this 150-foot level. The guy wire paths to ground give the reduction in current on the coax.

A comparison of the two examples shows that the grounding of the coax at each guy location will give a higher coax current between the 150-foot to 100-foot levels. Here it is increased 39% over the "bottom only" grounding situation. What if we didn't ground it at the 100-foot level, but kept the 150-foot, 50-foot and 15-foot locations grounded?

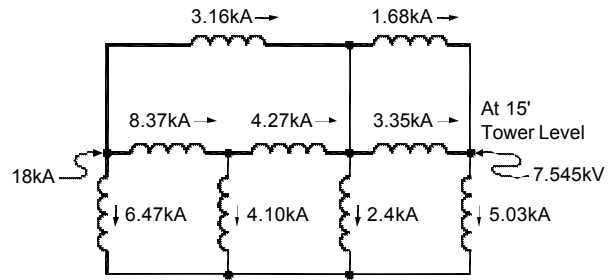

Average Proportional Current is 2.775kA.

The coax currents are somewhere in-between the levels of "grounding at each guy location" and "grounding at the 15-foot level only".

If we look at the average coax current, we have a maximum 2.79kA for the single ground at 15 feet and a minimum of 2.733kA for the multi-guy grounding. Note the voltage at the 15-foot level on each example. They do not vary more than about 8%. This is a very small reduction for the amount of effort and cost involved in the additional grounding installation.

MUTUAL COUPLING

Mutual coupling is the name given to the linkage of the magnetic lines of flux between one conductor and another. In most cases, it is described using two non-ferrous (non-magnetic) conductors (copper, not steel). However, in our applications, we have one of each. The tower (steel) will cause the lines of flux to be concentrated in close proximity. We also need to take into account that each tower leg will share (divide) the current passing through the tower. A coax running down one leg would not have a very large coefficient of coupling of flux lines, even with the steel concentration. We estimated this coefficient to be 0.166.

Using the formula:

$$M = k \sqrt{L_1 L_2}$$

where k is 0.166 and L_1 and L_2 are the tower and coax inductances, respectively.

In the self-supporting tower where the tower had $40\mu\text{H}$ and the run of coax was about $72\mu\text{H}$, M would be $8.9\mu\text{H}$. This is a significant amount of additional inductance. At 18kA , our strike current and 2 microseconds rise time, this is an $L \text{ di/dt}$ of 80.2kV or a 33% increase!

Additional worst case consideration might be given to the possibility of a low inductance self supporting structure with a single coax running down the side. Depending on how the coax was attached, if the structure was tall (> 150 feet), and the coax shield was grounded to the structure at the top and bottom only, there would be a large difference in inductance between the two paths. Magnetic field coupling (k) between the two paths would create a reverse EMF on the coax, opposing the downward energy flow. At some point, approximately in the middle of the structure, there could be a high peak voltage differential between the coax shield and the structure. This high peak voltage differential could arc through the coax PVC outer jacket to the structure, damaging the coax shield. Additional grounding kits could solve this problem.

In the guyed tower, the coefficient of coupling would be the same. But since there is less total inductance with current flow on the guys, there will be less current on the coax, making the dv/dt less dramatic. The grounding of the coax shield along the tower will segment the amounts of mutual inductance. The mutual coupled inductance will then add about 7% to all inductances and voltages we have calculated on all combinations of coax shield grounding.

So far, we have taken a look at the current distribution on two theoretical towers for a typical strike. What happens to the coax line and the connected equipment in the building when this potential is present?

IT'S WRONG!

If we look at where the coax leaves the tower on its way to the equipment building, we see the tower will carry the major part of the surge to earth. The outside master ground bar will have 4.3kA delivered to it by the coax and be elevated to 7.3kV above earth ground. The master "ground bar" is no longer a ground, but instead a source for elevated potential to be transferred to whatever equipment is connected to it! The above current and voltage examples are only true for this configuration. Add another coax line or a grounded guy wire and it is completely different. (The purpose of this exercise is to show that the grounding of the coax at this elevated point on the tower sends a significant amount of energy through the coax shield towards the equipment. There is a better way.)

THE REAL FIX!

Even though this is accepted practice, and what you will see most often in the field, *it is incorrect*. By continuing the coax further down the tower to almost ground level and then grounding the shield to the tower (just above the tower leg ground connection), the instantaneous voltage gradient on the coax shield would be almost zero. Theoretically, the coax shield current would also be almost nothing. "Theoretically" because both the tower ground system and the equipment ground must not only be interconnected (grounded) below grade to have this be true, but they must also be large enough so that ground saturation will be minimal. Running additional ground wires from the coax ground kits to the tower base will not help either, unless you can find the theoretical zero inductance conductor!

ADVANTAGES

DISADVANTAGES

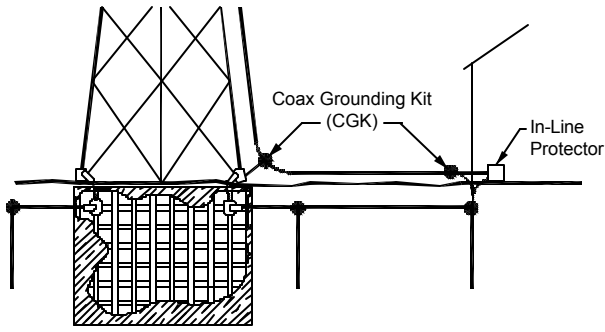

BEST

Low L di/dt voltage

- 1) Coax must make tight bends.
- 2) Coax enters at floor level.

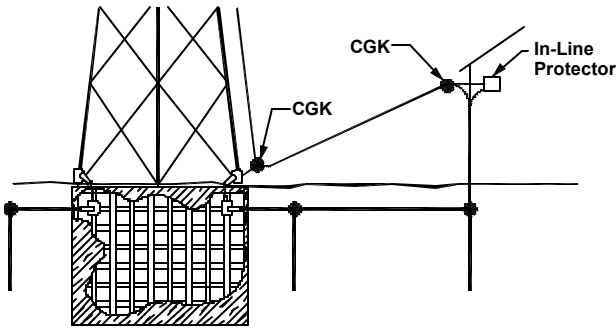

GOOD

Low L di/dt at tower

- 1) Large L di/dt for in line protector unless large grounding surface area conductor is used for building CGK and protector.
- 2) Sloped line will intercept tower mag fields.

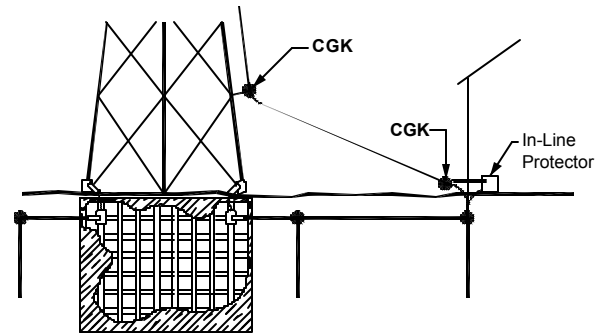

OK

Low L di/dt at building

- 1) Coax must enter at floor level.
- 2) Sloped line will intercept tower mag fields.

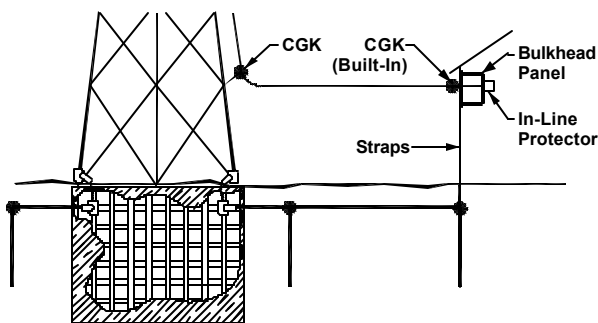

ACCEPTABLE

- 1) Enters building high.
- 2) Does not intercept tower mag field.

Large straps cost more but are needed to reduce L di/dt voltage

Tower Strikes & Solutions

Most sites in use today separate the coax cables from the tower and route them toward the building entrance panel at a relatively high point on the tower, typically 8 to 15 feet above the tower base. This practice is the single most damaging source of lightning energy directed toward the equipment.

Chapter 1 discussed the best way to reduce coax cable shield currents directed toward the equipment: Take the coax cables to the base of the tower and ground the shields there, routing them at ground level or below to an entrance panel at ground level.

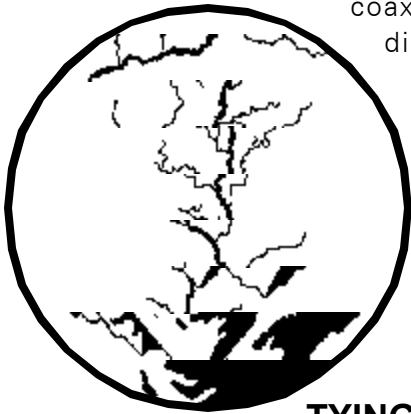

TYING IT ALL TOGETHER

One grounding system must be formed interconnecting all other site grounds. A lightning strike possesses a given amount of current and by installing a radial ground system around the tower and a perimeter ground loop around the equipment building, the division of current will send most of the lightning strike energy to be dispersed by the radials. A below-grade perimeter loop around the building will also reduce the amount of step voltage inside the loop. This is due to the repelling effect of like charge emanating from all points on the loop, reducing current flow through concrete floors, protecting both equipment and personnel.

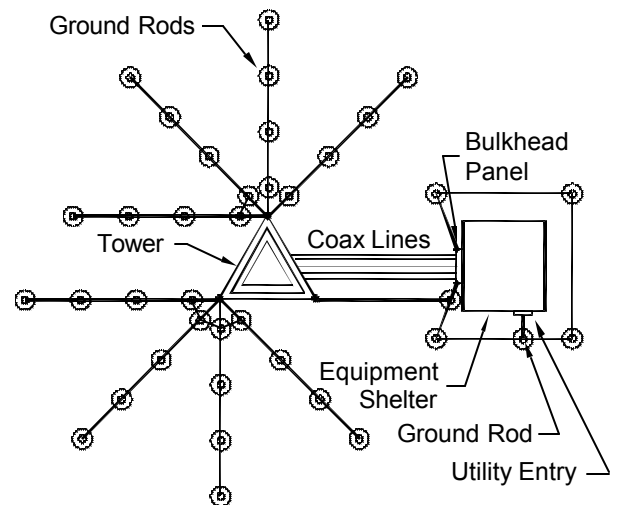

Connecting all ground rods together forming a "single point" ground system.

The lightning pulse series is a "fast rise time" event requiring a ground system capable of dispersing large amounts of electrons into the soil very quickly with minimum ground potential rise. This requires multiple paralleled inductances shunted by conductive earth. Multiple tower radials with ground rods (parallel inductances reduce overall inductance, improving the transient response) have been proven to be the most effective method of grounding towers.

TOWER TO GROUND CONNECTION

Most self-supporting or guyed tower legs are individually bolted to plates or brackets imbedded in a concrete pad. If the plates, brackets, or steel mesh in the concrete are interconnected (bonded together), a "Ufer" ground is established. Radials with ground rods must be attached to the Ufer to further lower the impedance and improve the ground system's transient response.

Conductors from the tower legs to the radial system must have low inductance (large circumference) to direct lightning's fast rise time peak current towards ground with minimum voltage drop.

The method of attachment to the legs and ground system should be very low resistance and not subject to corrosion. Accepted practice is to lug a large round conductor to a flange bolt, or exothermic weld it to the flange or bracket. The conductor is routed, on top of the concrete pad, to where it goes below grade to the ground system. Emphasis has been placed on 8-inch minimum radius bends for lightning current carrying conductors, suspended in air, to minimize inductance. Higher inductive right angle bends or connections should be avoided if possible, but the alternative trade off may be worse.

If tighter bends are required to get an overall lower inductance ground conductor, we recommend solid bond copper strap.

Some guyed towers use a *tapered base* with a ball joint on a concrete pier. For example, the nearest ground rod is some 24 inches (vertical + horizontal) from the top of the concrete pier. If we want to utilize the Ufer effect, connect three or four large conductors (one per leg) from the bolts on the plate above the ball joint to the bolts on the plate below the ball joint. Continue the same conductor (if possible) down the sides of the pier to the ground rod/radials using optimum routing as determined below.

Assuming the wire gauge is #2/0, the inductance is approximately 0.32 μ H/ft. Knowing the distance, the inductance for each route can be calculated. Each 90-degree bend develops about 0.1mH of additional inductance. Each sharp angle has about 0.15 μ H inductance.

Solid bond copper strap is once again the better choice for a low inductance conductor, however the interconnections to the tower base can be troublesome. Some engineers have solved the strap interconnect problem by brazing steel tabs to leg pads (in contact with the concrete), then

exothermically welding the copper strap to the steel tab. The tab/strap interface is coated with a weather-proof sealer to eliminate corrosion problems. This is a good idea but, contact the tower manufacturer before drilling or welding to the tower!

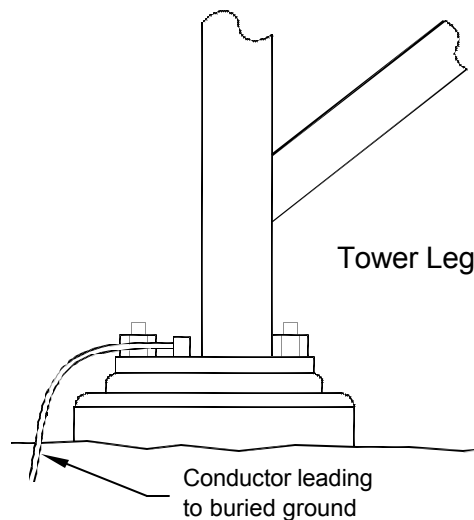

EQUIPMENT STRESS

Even with a "perfect" ground system, voltage stress during a lightning strike may still be experienced by the equipment if the coaxial cables are not brought to the base of the tower before the outside shield is grounded, or if a proper bulkhead panel/ground bar connection is not utilized.

In Chapter One we examined the tower's inductance and the associated voltage drops during a strike. A tower connection at 15 feet above the earth may appear to be a good grounding point. An ohm meter might show it to be a "good dc ground". But it is really a poor, possibly dangerous grounding location due to the high peak voltages present during the strike.

For a 1-5/8" coax cable, it is virtually impossible to make as sharp a bend as is necessary to ground the shield at the tower base. Yet in the absence of other grounding methods, it is essential to ground the shield at this point to keep the shield voltage near zero.

If the coax slopes downward from an elevated point on the tower so it enters the equipment building at or very near ground level, another shield grounding kit should be incorporated at the wall penetration.

If either method is not practical and the coax must enter the building elevated above the earth, then a large surface area *bulkhead panel* should be used to ensure a low inductance route to earth ground.

BULKHEAD PANEL

Bulkhead panels have been used for many years. The initial reason was to provide the equipment building with a structurally strong entry point for one or more cables. The bulkhead panel was a rigid metal plate that covered a penetrating hole in the building's wall.

In installations where the coax lines must exit high on the tower, it is best to terminate the feeder coax at a bulkhead plate/coax center pin protector and run a smaller more flexible coax jumper from the protector to the equipment.

Grounding the entry bulkhead panel usually consisted of connecting a ground wire to it. In most installations a master ground bar (MGB) is used with coax cable ground kits connected and a ground wire routed from the MGB down the wall to the site ground system. *A wire like this is ineffective for fast rise time pulses because of its inductance.*

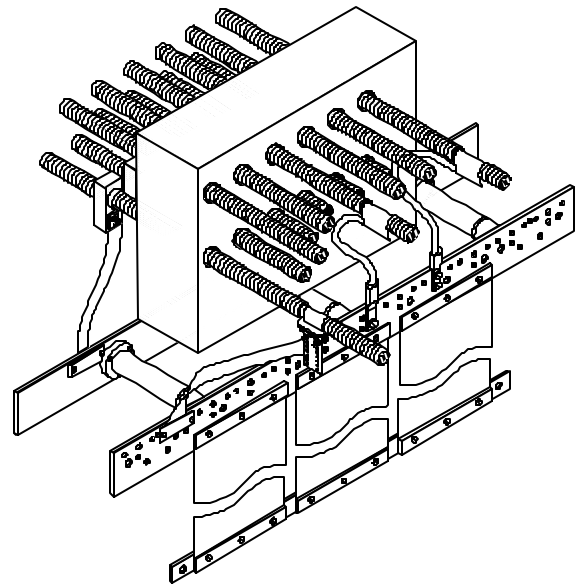
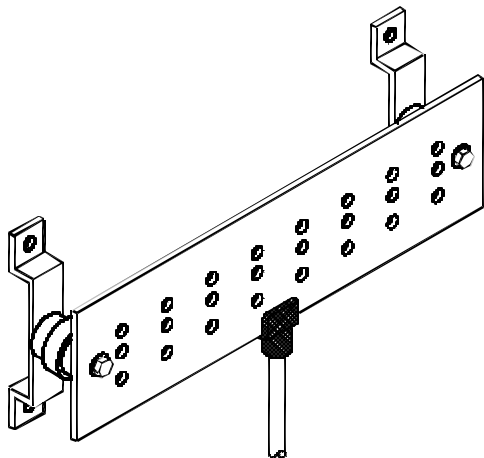

Outside/Inside Master Ground Bar
(PolyPhaser - GSIE)

If a larger bulkhead plate were continuously extended from the entrance opening down the building exterior and beneath the soil to the ground system, a low inductance interconnection to the ground system could be made. (Because of its large surface area - skin effect - and large W/H ratio, it should be less inductive than an equal height on the tower.) If the coax cable were grounded with a short low inductance connection to such a bulkhead plate, lightning surge current would be stripped from the cable shield. A copper "grounding finger" should be used and weather protected by a boot. However the ease of installation (weight) and cost of such a full length copper extension plate may be prohibitive. A cost effective variation is to substitute copper strap material for the thicker full length panel material going to ground, making it lighter, easier to install, and less expensive. The strap would be affixed to the building with silicone and then covered or painted for camouflage and wind resistance.

Flat strap is the best conductor for a grounding system. It has maximum surface area, for skin effect and low inductance. Strap actually has less inductance than wire for a given angle bend and can be bent to a tighter radius. Mutual inductance,

the cross coupling of the magnetic fields at the bend, is the reason for the added inductance of a bend. The distance from one side of the strap, when bent, is further away from the opposite side of the strap by the angle it makes, plus the width of the strap. The distance is greater so the mutual coupling is less. Also, the magnetic field susceptibility is maximum at its edges and it is similar to a dipole antenna. Therefore, it is less likely to intercept tower magnetic fields if its flat side is oriented toward the tower.

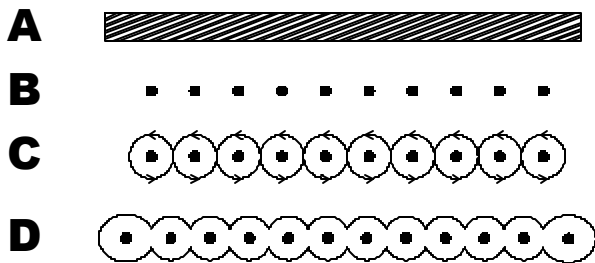

A) Copper strap may be looked at as if made from an infinite number of infinitely small wires spaced infinitely close together. B) The mag field of each wire C) is shown and they will add vectorially D) toward the edges.

One can calculate expected peak current and voltage drops for ground conductors and, if done properly, will get accurate inductance value requirements. The inductance requirements can then be translated to physical conductor dimensions. The goal is to reduce the voltage drop to a minimum. This is a valid exercise and good engineering "practice".

Master Ground Bar (MGB)

An easier way to determine *minimum* ground down-conductor sizes would be to compare the total of all circumferences of incoming surge bearing conductors from the tower (coax cables, conduits), to the total circumferences of all grounding down-conductors.

If the length of the grounding down-conductor(s) from the MGB to where it goes below grade does not exceed the length of the coax(s) horizontal run from the tower, the total down conductor circumferences should be at least the total of all

incoming coax cable and conduit circumferences. Wide copper strap will give the largest circumference ("skin effect") with the least amount of copper.

External cable trays or ice bridges should not be in contact with both the tower and the building ground system. Isolate and support the cable tray at the building end. Only the coaxial cables should complete the circuit.

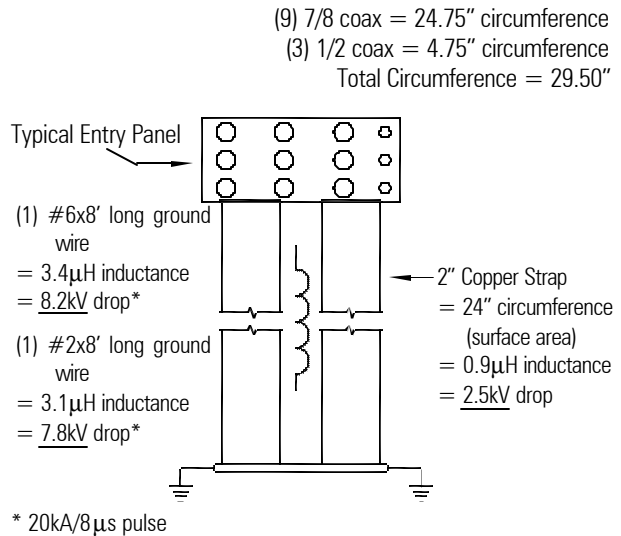

Ground conductor circumferences should equal the combined circumferences of all coaxial cables.

CENTER CONDUCTOR

Shield currents can almost be eliminated with proper grounding techniques. However, the center conductor surge current should also be eliminated before the current damages the equipment. A dc blocked type lightning protector (see Chapter 6) can prevent the center conductor's surge energy from reaching the equipment if it is mounted (grounded) to the bulkhead panel. The use of a dc blocked center pin protector will prevent the sharing of differential surge energy present on the coax center conductor due to high frequency roll off and velocity of propagation differences between coax cable shield and center conductor.

SUBPANEL

To further protect and restrict access to the coax-to-center pin protector connection, a “U” shaped subpanel (see page 16) could be mounted/grounded to the bulkhead front plate. The subpanel is attached so it protrudes from the main panel through the penetrating hole inside the building and creates a secondary surface on which the protectors are mounted and grounded. All connectors are accessible from inside the building for tests and changes. If waveguide is used, it would extend straight through, since a center pin protector is not needed. The grounding finger under the weather boot (see bulkhead drawing), accomplishes proper grounding of the waveguide and coax cables. The subpanel would be deep enough for concrete block construction. The added depth allows for external coax feeder entry angle correction and jumper support in the absence of internal cable trays.

The bulkhead panel is made of 1/8” half hard C110 (solid copper). Only this hardness of copper can be properly tapped for screw threads. The C110 copper weighs 5.81 pounds per square foot. Mounting hardware used to join the subpanel to the bulkhead is 18-8 stainless steel.

For small to medium size sites, the bulkhead panel should be the central grounding point inside the building for single point grounding procedures. Holes can be drilled into the U panel for bonding straps and grounding cables from inside racks of equipment. The bulkhead panel then serves as the master ground window or ground bus (MGB).

Other types of bulkhead entry panels are open on the equipment side with no “U” panel for restricted space locations. An outside/inside ground bar assembly can be retrofitted to existing sites for single point use. Attachment points are provided for 6” strap external ground conductors and 1-1/2” strap internal connections for grounding coaxial protectors.

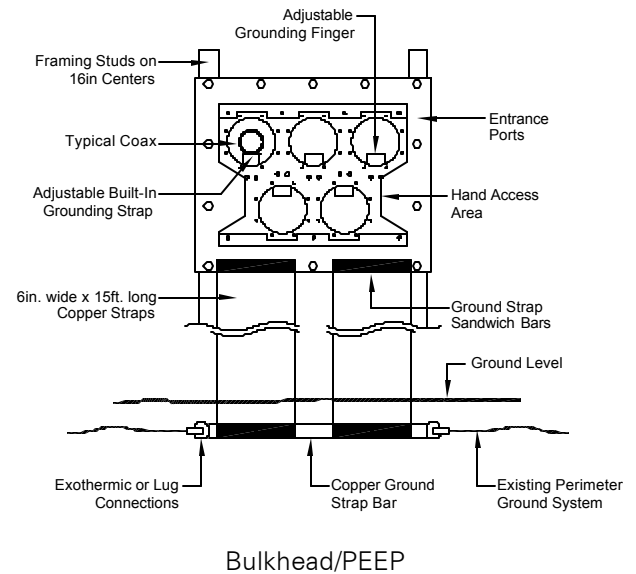

SINGLE POINT GROUNDING

Surely everyone has heard of the safety procedure that says to keep one hand in your pocket while working around high voltages. If the body does not complete a circuit, there is no current flow and danger is averted.

For small- to medium-size equipment rooms, it is best to have the equipment’s input/output (I/O) protector grounds and equipment chassis tied together. The telephone line protectors, coax protectors, and power line protectors are then grounded either on a bulkhead panel or mounted together on a single point ground plate and tied to system ground. Equipment chassis ground would then be connected by a low inductance strap to this ground point.

An exterior ground system should consist of the tower leg grounds (radials and rods), power company ground rod(s), and a below-grade copper strap sandwich bar connecting the bulkhead strap downconductors to the below-grade building perimeter ground loop.

To keep equipment safe in the event of a lightning strike, the same one-connection concept applies. *Single point grounding is a grounding technique that ties all the equipment in a building together and grounds it at one common point.* Implementing this technique is quite easy.

The single point ground must be implemented properly so the coaxial protector can do its job. As Chapter One's example illustrates, the outside coax ground plate could rise to 7.3kV above the earth ground system, emphasizing the importance of a single point grounding concept. The bulkhead or "PEEP" (PolyPhaser Earthed Entry Panel), with proper coaxial cable protectors installed, would be the primary "firewall" protecting equipment. If the equipment has a separate path to earth ground in addition to the bulkhead or PEEP, the added parallel path could allow strike current to flow through the equipment.

I/O PORTS

For repeater installations with a single telephone interconnect, there would be three Input/Output (I/O) ports: the coax cables, power lines, and telephone lines. These I/O's can be either a lightning *source* or *sink*. Lightning surge energy may originate from one I/O and exit another I/O causing circuit damage in equipment connected to one, or perhaps all of the I/O's. Since it is impossible to ground an I/O, a surge protector must be provided for each.

The surge protector's purpose is to divert and isolate the equipment from the surge. Whenever a surge exceeds a preset voltage, the surge protector diverts the surge to a ground sink. By installing a surge protector at each I/O, it is possible to configure a grounding scheme that allows the equipment to survive a lightning strike.

A single point ground system would be created, if all the I/O surge protectors were grounded/mounted onto a bulkhead panel or MGB. The equipment racks are also bonded to the MGB. Surge energy stripped from the lines by the coax cable ground kits and each of the surge protectors is diverted to ground via a single path.

Imagine each I/O port to be a hand or a foot. If a hand or a foot touched a high-voltage dc source at a single point, no current would flow through the body and no injury would occur. (The surge current necessary to elevate the body up to this higher voltage might be felt.) The body must therefore be insulated from everything else; no other path for current flow can exist.

As in the above example, the equipment must be properly isolated from conductive flooring. By mounting the surge protectors on the same bulkhead or metal plate connected to a common ground, no surge current flows between the I/O's and no voltage drop is created (no ground loop). Damage does not occur since the equipment chassis is also grounded to this same point. The surge protectors have low impedance between them, so no voltage drop can develop.

PERSONNEL SAFETY & THE SINGLE POINT GROUND

Why protect the equipment but risk the technician? *The first and most obvious answer is he should not be there working on equipment during a thunderstorm!*

A low resistance single point ground, with insulated racks, *could still* allow the potential on the racks to rise to dangerous levels. During a "normal" 18kA strike with 2 or 3 return strokes of 9kA each, the event would probably be over before the rack's capacitance would be charged to dangerous levels. If the event were a 140 kA strike with 10 or 11 return strokes of 70 kA each, the whole site would be a dangerous place. It is a difficult and unpopular decision to compromise safety no matter what the statistics are. A technician working on equipment during a thunderstorm *is at risk no matter what kind of grounding scheme is used*. There are some

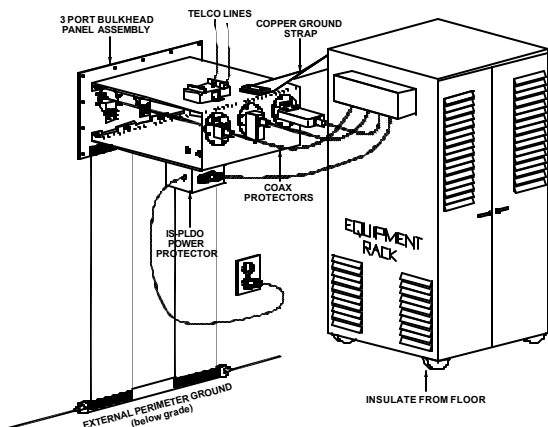

Bulkhead Single Point Ground

Preferred method of grounding I/O protectors for coax, telephone line and power line. The bulkhead plate in turn connects to the perimeter ground outside the equipment hut.

compromises to the single point ground that can be implemented to increase safety (at some sacrifice of system effectiveness).

- Install an overhead insulated bus bar connected *only* to the single point ground and extending out and around the inside walls of the equipment room in a “U” shape. *Do not* connect any additional ground conductors downward to the outside below grade perimeter ground.
- Connect all metallic objects within the technician’s reach (while touching the equipment rack) to the bus bar. The bus bar ground should be the only ground connection for the object. Even after considering propagation caused peak differentials, the voltage should nearly equal the rack potential.
- Place high voltage insulating rubber mats on the conductive floor where technicians would stand.

If a bus bar connected object is also connected to a different ground point, there could be additional magnetic field in the building as a consequence of current flow through the bus bar and connected object to ground. If outside low inductance conductors (multiple copper straps) are installed at the bulkhead or MGB, the peak voltage drop will be minimal, reducing current flow in the building.

The only satisfactory approach to lightning protection and safety is an integrated set of grounding techniques, protectors, and safety procedures all working together (You can’t engineer common sense).

PROTECTOR MOUNTING

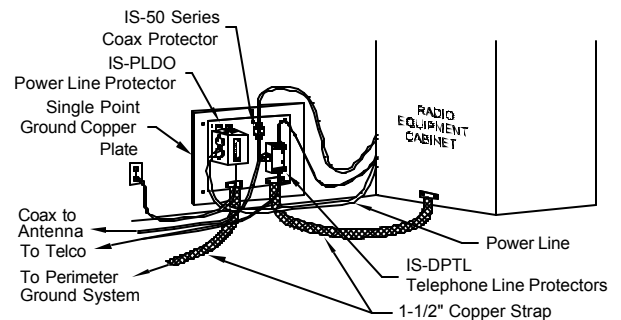

Example of Single Point Ground without Bulkhead

If the bulkhead plate was not installed at the time the equipment hut was built, an alternative grounding method may be used. Although the interconnect inductance of copper strap is greater, protectors may be mounted to a copper plate, which is connected by strap to the perimeter ground.

Current that is diverted by the protectors should go to ground by a path whose inductance is as low as possible. If a grounded bulkhead panel with its large surface area, low inductance ground straps is not used, the next best place for mounting the surge protectors would be on an inside, floor-level, wall-mounted plate. A low inductance interconnection to the perimeter ground is essential.

No matter how low the protector path inductance may be, it still has some inductance. Since the surge protectors send current through this inductance, a voltage drop ($L di/dt$) is created. This voltage drop may cause problems for sensitive equipment. Control lines or balanced lines, for example, may become elevated above chassis ground. To ensure the equipment chassis is held to the same potential as the surge protectors, a low inductance connection between the equipment chassis and the bulkhead panel or protector panel is required. This conductor should have a lower inductance than the coaxial shield.

SHIELD CURRENT FLOW

If radials, rods, and a single point ground for site protectors and equipment are installed, have all the possible problems been eliminated? Very low surge current could still flow on the coax shield within the equipment building toward the rack even though it is insulated from conductive flooring.

The equipment chassis or rack, like your body, has the ability to accept a charge (capacitance). The rack is elevated in potential to the $L di/dt$ (inductive voltage drop) of the interconnection to the exterior ground via the MGB. Current must flow along the coax jumper shield and other ground conductors to bring the rack to this higher potential. A magnetic field is created inside the room by the lightning pulse current surge charging the rack's capacitance through the coax shield and ground conductors. The path(s) from the protector panel or MGB to the equipment radiate the field.

PolyPhaser manufactures a coax protector that dc blocks the center conductor *and* the shield (to 2kV). There is no dc continuity between the antenna coax shield and the equipment side shield.

LIGHTNING ELECTROMAGNETIC PULSE

The fast rise time to peak current creates an electromagnetic field (electrostatic and magnetic fields) that radiates out from the stroke discharge path to earth. The amplitude/frequency spectra of the radiated component would depend on the current density/rise time of the stroke and the distance from it. Frequencies in the pulse extend well into the communications bands and can couple damaging energy to equipment.

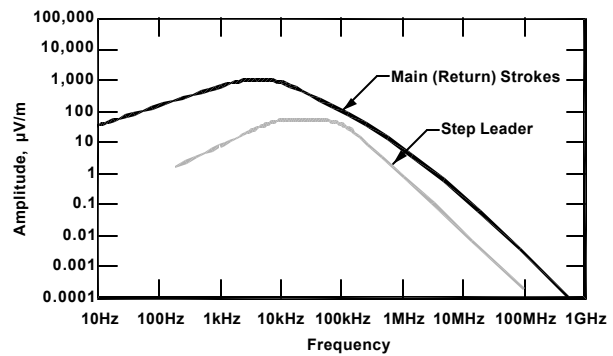

Amplitude spectra of the radiation component of lightning discharges.

MAGNETIC SHIELDING

Lightning's high current means that the associated magnetic fields from the tower will radiate and cross couple to cable runs inside the equipment building. Sites are usually designed to have a 5 ohm ground system, but the building is placed close to the tower with little or no magnetic shielding. The distance, between the tower and the building, is usually kept small so the transmission lines are short. This places a heavier burden on your ground system to absorb and quickly conduct the strike energy away from the tower base. Magnetic fields from the close spaced tower will cut through the equipment building causing induced damage to interconnected equipment.

Aluminum buildings, like aluminum chassis, do little to attenuate low frequency magnetic fields. Concrete with steel mesh or rebar, which is ferrous, will show some attenuation.

Steel shipping containers used as an equipment building, with either single or double walls will act as a faraday shield for both radiated (plane wave) RF energy and magnetic (H) fields. The containers also provide a uniform ground for the equipment from anywhere inside the container. Inside the container you may not need Electro Metal Conduit (EMT) for shielding, however, for other non-ferrous enclosures you should run all electrical and sensitive lines in separate EMT conduits.

DISTANCE VS. SHIELDING

The only alternative to a ferrous container is to use distance. Magnetic fields drop off at a rate of one over the distance (from the source) squared. To attenuate the strike's powerful magnetic field from entering the equipment and causing upset or damage, space the tower a practical distance from the building. Distance will also add length to transmission lines which gives additional series inductance (voltage drop), forcing more surge current down to the tower ground. More transmission line will not pick up more magnetic field. The straight run from the tower to the building is orthogonal to the magnetic field from the tower and will not pick up any additional surge.

Bulkhead panel strap orientation is at minimum for H field coupling. The most coupling for both E and H fields is off the strap's sharp edges. Therefore, the strap(s) will couple less energy than a round conductor.

LATENT DAMAGE

Stress to electronic components can cause failure at a later date. The US military has spent large sums of money to study what has been termed "latent damage". Latent damage leads to reduced MTBF (Mean Time Before Failure) of equipment. Lightning stress from coupled magnetic fields to high speed, small junction semiconductors, can lead to unexplainable failures. Since the user does not have design control over the PC board layout, trace length, proper I/O protection, or the equipment enclosure, EMP and RFI environmental considerations need to be considered.

LARGE SITE GROUNDING AND SHIELDING

At very large sites (over 30 x 50 feet) where lightning shielding is important but steel sheets cannot be used to make a shielded room, an internal ground halo (with multiple downconductors connected to non-electronic fixtures) may be provided around the room as an inexpensive

alternative. It serves to intercept the low frequencies of lightning, *although it is not very effective*. It is often used for (multi-point) grounding of equipment racks. However, if also connected to the Bulkhead or MGB, large currents would flow through the multiple ground conductors *creating* an intense magnetic field instead of absorbing it.

GROUNDING EQUIPMENT CHASSIS

Racks are commonly used to mount larger base station equipment and repeaters. Rack panels may be painted or the rails where they are mounted may become oxidized. The paint and oxidation may have enough resistance to prevent the rails from being an adequate interconnecting grounding conductor.

Under non-screen room conditions and within high RF environments, such as those found at broadcast transmitter sites, the contact between the dissimilar metals of the bolts, rack rails, and equipment panels can form "diodes". These "diodes" have been known to cause intermodulation interference and audio rectification.

One way to tie the equipment together is shown. Insulators support the vertical ground bus. Each piece of equipment is connected to the bus by a short strap. Any "noise" created by poor joints and dissimilar metal contact within the rack is "shorted out" by the short strap. The short strap may be a resonant antenna near the frequency of the strong RF field from a nearby or co-located high-power broadcast. It may be resonant near your operating frequency, or some other intermediate frequency used by your equipment. A grid dip meter may be used to determine whether the loop is resonant at a frequency that could cause a problem.

The loop's resonant frequency can be found with other methods. A spectrum analyzer may be link-coupled to the loop and observed to see where the noise floor rises when the loop is opened and closed. The same technique could be used with a service monitor tuned in the AM mode to a quiet channel. (Note: Front-end overloading could give false readings.)

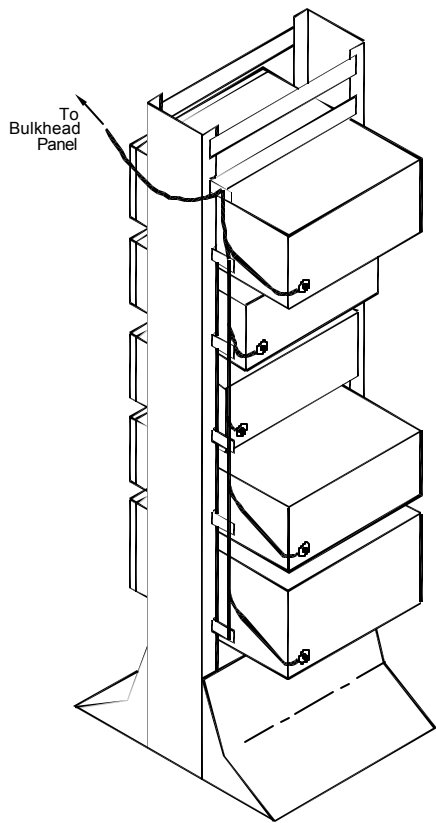

Each equipment chassis in a rack is connected by short strap to a vertical grounding bus suspended by insulators.

A possible alternative uses corrosion resistant conductive plating or metal treatment on the rack rails and chassis mounted rack brackets.

GROUNDING SCREEN ROOMS

Screen rooms work best for shielding equipment from high RF and electromagnetic pulse (EMP) fields associated with high-power transmitters, lightning strikes, and high-altitude nuclear detonations. However, proper grounding of the screen room is required to meet specifications.

The screen room manufacturer should be able to detail the techniques that ensure maximum screen room effectiveness. All I/O's to the screen room should be filtered and protected. All protectors should be mounted to the outside wall of a double screened enclosure.

MULTI-POINT GROUNDING

Some microprocessor controlled equipment makers have attempted to reduce noise and RF on the logic bus (when connected to RF equipment) by using multi-point grounding techniques.

When the site is a large installation, it is not always practical to install a low inductance interconnection back to the single point ground panel (unless a screen room or container wall is used). Connections to an installed "halo loop" (an isolated conductor run high on the inner walls connected back to the single point ground with additional spaced, downward ground leads to the below grade perimeter ground loop) are attempted to equalize potential and reduce noise. The propagation differentials during a lightning "event" between the coax jumpers connected directly to the rack from the entry panel (MGB or Bulkhead) and the entire inductive path from the upward connected equipment "halo grounds" and their downward ground conductors, will cause current flow and an $L \frac{di}{dt}$ potential through the halo until it is also equalized. Additional magnetic field will be radiated from this current flow.

Therefore, *independent* rack interconnects from the top to the below grade perimeter ground loop would seem to be the answer. *The problems that can arise from not having a single point ground (lightning damage) can be worse than the possible noise from the RF equipment.* Each site design would need evaluation and compromise.

Electrons take time to travel from one position to another (propagation time). For this reason, care must be taken in designing the perimeter ground system and spacing the connecting points for a multi-point system.

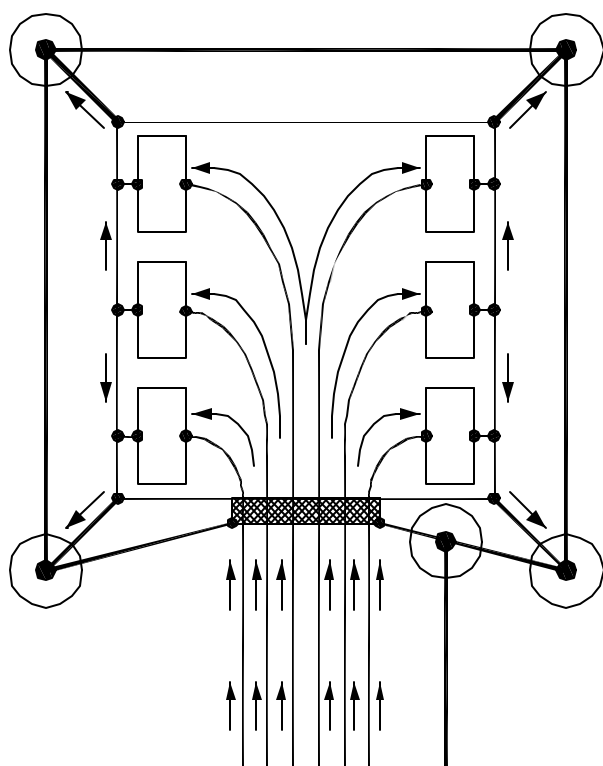

While single-point grounding is in most cases preferred, large installations may make use of multi-point grounding to overcome the inductance of a ground interconnect conductor suspended in the air within the equipment hut. Careful design is required.

For large equipment rooms, using many connections to the perimeter ground is a viable method. As a result, some surge current will enter the equipment room. However, with multiple paths to ground, the total number of paths divides the current. In this way the current could be reduced to a harmless amount (each $L \, di/dt$ is small enough so no breakdown occurs in the equipment). Ideally, each path from each piece of equipment to the perimeter ground should be of equal length. This means that for a typical site, the downward paths to the perimeter ground system should be interconnected to the inside halo about every two feet! This is rarely done and is why the halo has problems! It is easier (and safer) to do a single point ground system than it is to install multiple halo to perimeter ground connections.

FAST PROPAGATION TIME

The multi-point ground design concept places more emphasis on the perimeter ground connections. Since the I/O's are the only means by which current may enter the room, the lower the interconnect inductance to the perimeter ground by the numerous parallel paths, the smaller the $L \, di/dt$ voltage present. The propagation time of the ground system and the timing of the current in the earth around the hut can cause problems with a multi-point ground that is not present with a single point ground.

Look at how the surge propagates in the following series of drawings. Note that the majority of the surge is diverted out and away from the building. Also note the time it takes to progress around the building. This is why some currents traverse the parallel multi-point paths through the building in order to get to unsaturated perimeter ground locations. The race is between the speed of the perimeter ground loop versus the speed through the building. Normally if the ground system is good, it will be faster than the slightly more inductive path through the building. You can wind up fighting yourself by adding more paths, making the voltage drop less, which then makes the propagation time faster through the building. This means more current will traverse through the building with undesirable $L \, di/dt$ drops and current caused magnetic fields.

With a tower strike, and the perimeter ground loop propagation that follows, there could be a period of time when the bulkhead panel or MGB would be elevated in potential but the utility entry ground rod might be at a lower potential. During this period, current could flow through the ac power safety ground towards the neutral/ground bond at the main breaker panel. However, unless the strike current and number of return strokes were high, the small safety wire conductor would "choke off" most current flow and not be a cause for concern.

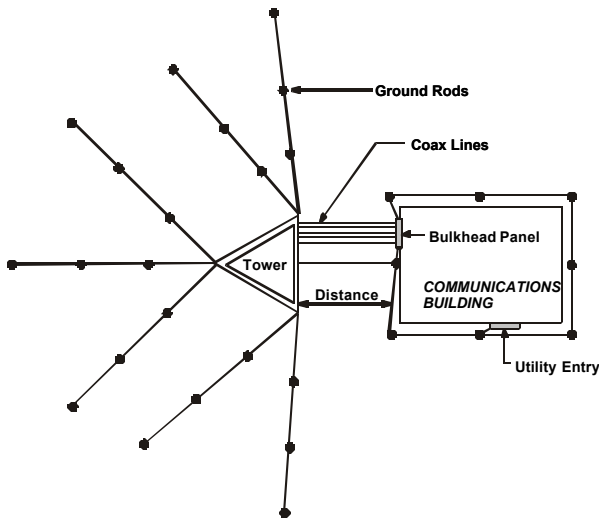

Recommended site grounding system about to be hit by lightning.

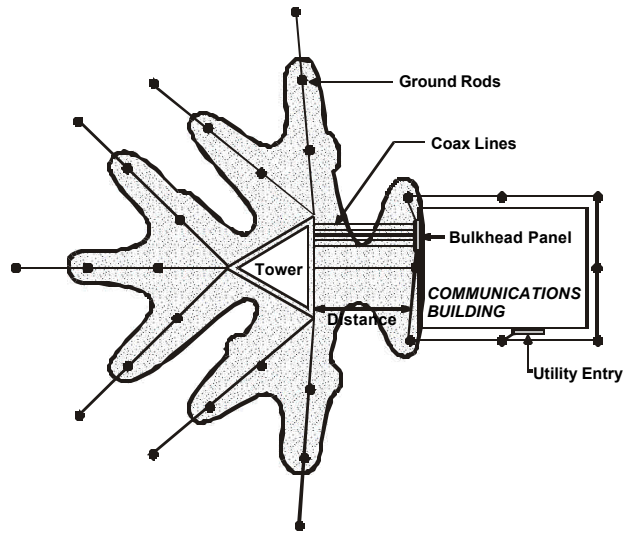

On a well-designed ground system, the strike energy spreads out initially from the building.

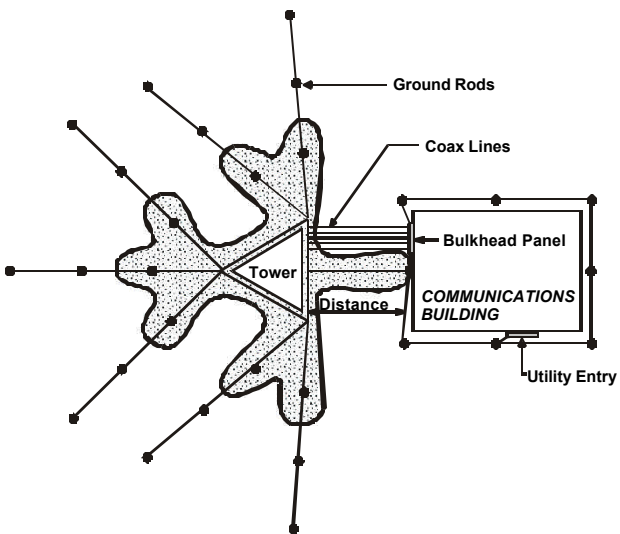

Neglecting the coax currents, the strike energy moves outward from the tower base along the radial line.

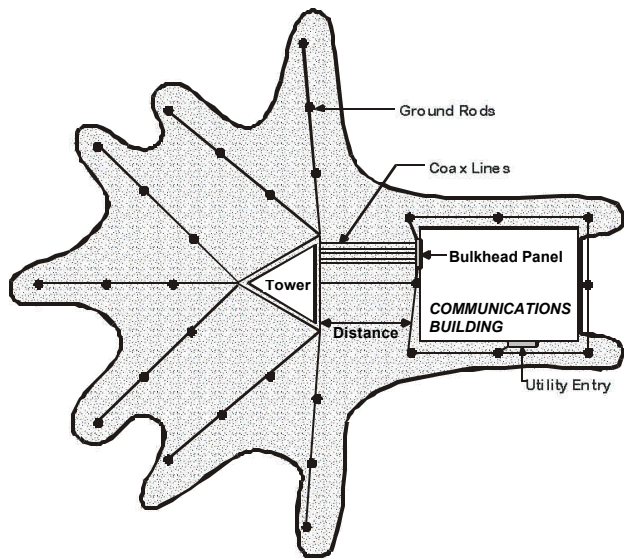

As it reaches and saturates the radial system, it will traverse the building perimeter.

EQUIPMENT ROOM “UFER” GROUNDS

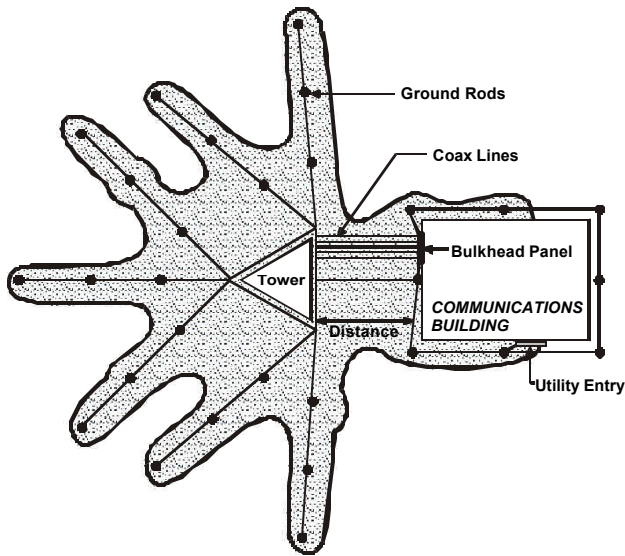

As it spreads, it loses energy due to the spreading and I-R losses.

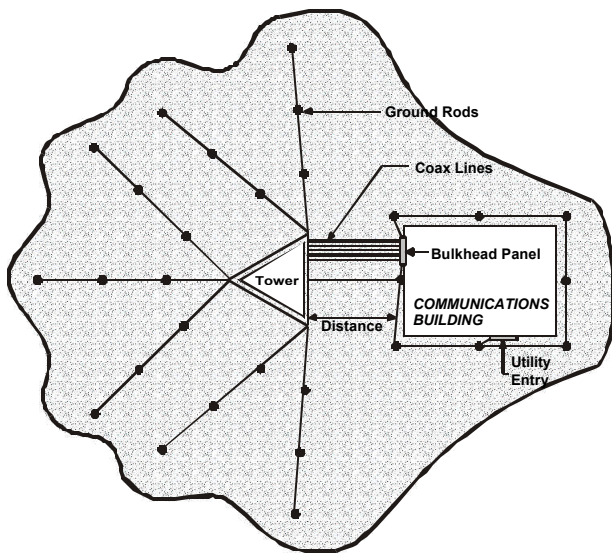

By the time it surrounds the building, the radials have spread out much of the energy.

A Ufer ground on new building construction should not be overlooked. Wire mesh encapsulated inside the building floor can be used as a low impedance grid. If the aesthetics of wires emanating from various locations on the building floor are not acceptable, the wire mesh may be bonded to an inside bus ground just above floor level for easier distribution. Two feet should be the maximum separation between vertical interconnections bonding the ceiling halo and the mesh floor bus. The mesh should likewise be connected to the outside perimeter ground at the same 2-foot intervals.

CABLE TRAYS

Large installations may make use of cable trays to support overhead runs of coax lines and other interconnecting wires. Ground the cable tray to the single point MGB or bulkhead. Connect the cable tray to the top of each rack. This prevents any arc-over from coax lines and reduces current flow through the coax cable jumper connector.

There should be jumpers to make the cable tray one conductive piece. The tray is an excellent way of grounding equipment racks together, since it has a very large surface area (low inductance).

If PolyPhaser isolated shield coax protectors (IS-IE series) are used, *isolate the tray and racks from the bulkhead panel*. The tray and racks will be grounded through the electrical ground connection back to the below grade perimeter ground loop. Coaxial jumper cables and ground conductors should be spaced from sensitive, low level signal lines. Ideally, signal lines should be run in EMT conduit.

INSULATED SUPPORT STRUCTURES

Wood or fiberglass support structures are not a good idea. They are an insulator. The cabinet earth ground, coaxial cables, and conduits on the insulated support would be the only conductive path for lightning energy. If a wood or fiberglass support must be used, the first step is to provide an alternate conductive path down the pole to earth. A lightning diverter (lightning rod) on top of the pole (above the antenna) with a separate 6-inch copper strap as an earth ground conductor, would provide a low inductance/large surface area conductive path to an earth ground system. The 6-inch copper strap earth ground conductor should be routed on the *opposite side* of the pole from the cables.

When large currents flow through any conductor, a strong magnetic field is developed around the conductor and can couple energy to other nearby conductors. A circular conductor will usually be surrounded with a cylindrical magnetic field varying in intensity as the current flow propagates down the conductor. The circular conductor's cylindrical field is indicative of its magnetic field susceptibility.

A copper strap will also develop a magnetic field closely aligned with its physical shape. As current propagates down the strap, a magnetic field develops close in to the flat portion and extends out from the edges. The strap's field pattern is also indicative of its magnetic field susceptibility.

If downward circular cables were arranged perpendicular to the flat side of the copper strap (opposite sides of wood pole), the magnetic field overlap would be reduced and mutual coupling would be minimized. The strap would conduct most of the current to earth ground with little reverse EMF developed on the cables.

Outdoor weather-proof cabinet grounding with an insulated support structure should be considered as follows:

- *If using a pad mounted outdoor cabinet,* all the energy on the large surface area conduits and/or coaxial cables would be directed towards the cabinet (entering from the top or side) with resultant large currents through the cabinet to local earth ground. Below grade cabinet bottom entry with a low ground connection on the coax would reduce current flow through the cabinet (recommended). Entering conduits and/or coaxial cable shields should be connected to a low resistance, fast transient response ground system through the cabinet's internal low inductance earth ground conductor. The usual center pin/shield propagation differential voltage would occur and could be blocked by an appropriate center pin protector.
- *If the Cabinet is pole mounted,* current flow from the coaxial cables shields (to the top of the cabinet) and conduit (going downward from the cabinet) would pass through the cabinet, duplexer housings, and connector panel PCB ground plane. Duplexer internal ground connections could sustain cumulative damage and PCB ground plane traces could be destroyed. If antenna coaxial cables were brought down the outside of the cabinet, looped up, and entering through a bottom connector (preferred), the lowest inductance path would be through the bottom panel of the cabinet to downward going conductors. However, large shield currents would flow through the connector shell of the surge bearing cable, traverse the cabinet's bottom plate, and continue out the connector shell of the downward cable. An interconnecting cable or shield ground kit(s) at the bottom of the cabinet, between cables ahead of the connectors, is recommended. Current flow through equipment would be minimized. A bulkhead type coaxial protector could be used as a bottom feed through connector.

GUY WIRE GROUNDING

Guyed towers are better at handling lightning surge currents than self-supporting towers. This is only true if the anchors are grounded properly. Some of the strike current traverses the guy wires (instead of the tower) and may be safely conducted into the guy anchor ground(s). With some of the current conducted by the guy wires, less is available to saturate the ground at the tower base.

Turnbuckles should not be a path for lightning current. If the turnbuckles are provided with a safety loop of guy cable (as they should be), the loops may be damaged due to arcing where they come into contact with the guy wires and turnbuckles.

The following diagram shows the preferred method of grounding the guy wires - tying them together above the loops and turnbuckles.

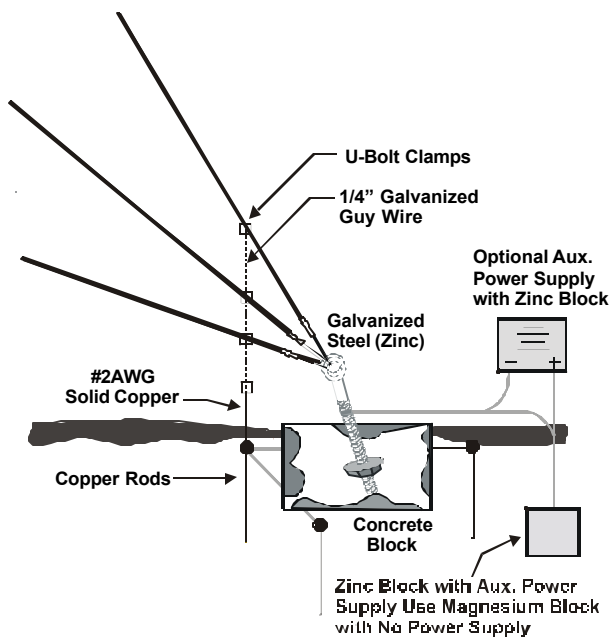

These connections should not be made with copper wire. When it rains, natural rain water has a pH of 5.5 to 6.0 which is acidic. Copper is only attacked by acids. Dripping water from the top copper wire will carry ions that react with the lower galvanized (zinc) guy wires. The reaction washes off the zinc coating, allowing rust to destroy the steel guy wire.

The best way to make the connection is with all galvanized materials. This includes the grounding wire, cable and clamps. The galvanized wire is bonded to a copper conductor (just above the earth's surface) that penetrates below grade to a radial system spreading the strike energy into the earth.

How high this bonded connection should be placed above the soil, depends upon local snowfall or flood levels. Snow's electrical conductivity, although low, can still cause battery action from the copper through the surface water to the zinc by the solar heating of the wires. The joint should be positioned above the usual snow or flood level.

The lead is dressed straight down from the highest to the lowest guy or with a slight tilt toward the tower at the top. After bonding to a guy wire, it should be dressed downward from the lower side to the next guy wire. Wire brush the members, removing all oxides, and then apply a joint compound if a pressure clamp is to be used.

To ensure no arcing will occur through the turnbuckle, a connection from the anchor plate to the ground rod is recommended. Interconnect leads that are suspended in the air, must be dressed so the bending radius is not sharper than eight inches.

For guy anchors in typical soil conditions, use two radials with ground rods. The radials need not be much longer than 20 feet each since there are lower currents due to the higher guy wire inductances. A chain link fence post can be used as part of the system. Bond to the fence post and continue the radial to 20 feet.

Grounding & Materials

We have discussed the lightning event, how sites get damaged, and how to direct this damaging energy to earth ground. But what (in this context) is ground? *Ground is the “sink” for electrons in a negative polarity cloud to earth strike.*

The problem is how to disperse the rapidly rising high frequency electron energy into the earth body very quickly, with minimum local ground potential rise.

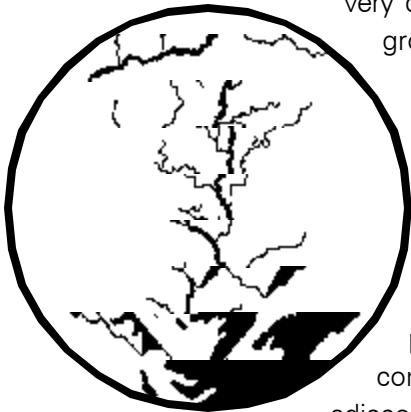

AC power frequency ground system designs do not always disperse high frequency energies (as in a lightning event) effectively. A 1994 study presented in the U.K. in 1997 compares the performance of adjacent horizontal earth grids at three different frequencies and examines the effect of adding close-in vertical ground rods. The authors conclude that horizontal components *with* vertical ground rods close in to the point of injection lower the resistance in a predictable way at power line frequencies, but reduce ground potential rise by an additional 27% at 1 MHz!

GROUND THEORY

A lightning strike is a local event. If the earth were a metal sphere, a lightning discharge would create a measurable ringing gradient on the sphere. However, the earth's resistance limits the current and dissipates the energy so the event becomes a mere pebble in the pond scenario.

When a lightning strike is delivered to a ground rod driven into average to poor conductivity soil, the rod will be surface charged at a calculable velocity factor. The charge will rise to a level where the concentration of E field lines cause the soil to break down at the rod point. This breakdown will momentarily increase the surface area of the rod. As the charge is being transferred, depleting the source, the E field at the rod tip will decrease below where the arc is sustained. The charge continues to disperse onto the surface of each grain of dirt surrounding the rod. (A charge can exist on an insulator, i.e., a glass rod after being rubbed with a piece of silk.) Because of the irregularity of the granular surface, the bumpy E fields inhibit the charge dispersal beyond a small range (sphere of influence).

If a ground rod is in poor conductivity soil, we can equate this to a rod being suspended in air, so rod inductance must be taken into account. The voltage drop, due to the inductive creation of a large magnetic field is expressed as: $E = L di/dt$ - where "di" is the lightning strike peak current, typically 18,000 amps, and "dt" is the rise time, approximately 2 μ s.

There is a limitation to the length that a single ground rod can penetrate poor conductivity soil on its way to water table and better conductive earth. Unless "shunted" by conductive earth, the series inductance of the rod section in poor conductivity soil, "chokes off" current flow to a possibly more conductive lower section creating a voltage drop along the more inductive top section. The top section of the rod "breaks down" the soil. There will be saturation and local ground potential rise due to this breakdown.

By having two rods connected in parallel, the overall inductance can be reduced. The spacing is important so each rod is able to “dump” into different volumes of earth. This dictates that the rod spacing be rather large (approximately 16 feet for two 8-foot rods in homogeneous soil) so the mutual inductive coupling between the rods would be small. Connecting two rods to the same volume of earth will cause saturation of that volume and limit the passage of any further charge in the given time span of the lightning strike.

Connecting a capacitance meter between two well-spaced rods will show capacitance is present in the soil. The soil surrounding each rod is resistively separated from the other. The cumulative resistance represents a poor insulator separating the two electrodes and forms a leaky capacitor.

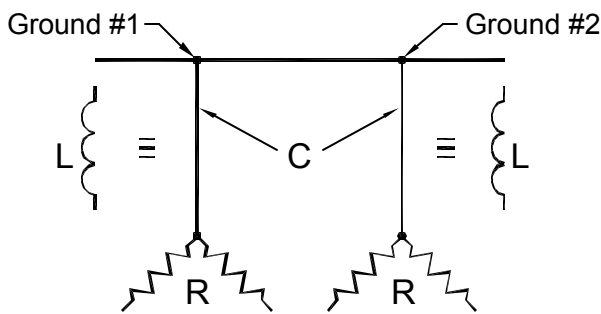

In the previous example, distributed resistance, inductance, and capacitance have been shown to exist. All can exist simultaneously. The interconnecting of these lumped elements is equal to that of a lossy transmission line or low pass filter. (Since earth R is high compared to the wire R, it is omitted.)

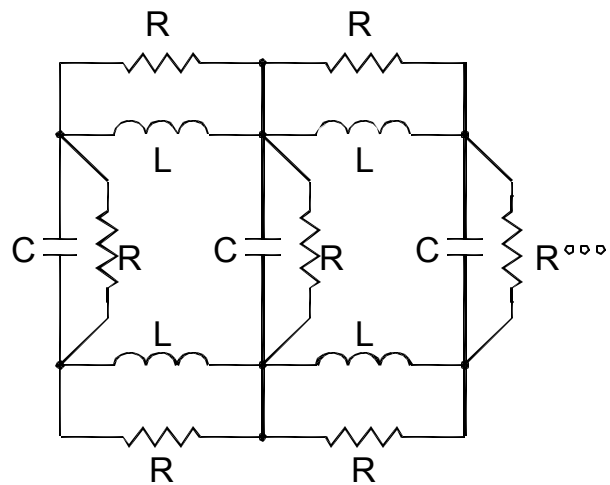

The only condition where both L and C can be eliminated is when R (earth resistance) = 0 ohms. (Here L is the total inductance of both wire, ground rod and the L of earth.)

Because a transmission line can simulate an earth ground system when not in a non-linear arc mode, a Velocity Factor could be calculated once L and C are known.

$$VF = \sqrt{\frac{1}{LC}}$$

However, this assumes the earth is of equally conductive makeup at all depths. If this type of soil were to be found, then calculating the surge impedance would be easy. This condition rarely occurs in nature.

Conventional ground testers are really impedance meters. They operate in the 70 to 300 Hz range and express the measurement in Ohms(Z). They were originally designed for the electric utility industry to measure ground resistance to assure circuit breaker operation should there be a ground fault. If the reactance of 30 feet of wire is <.004 ohms at 60Hz, the same 30 feet could have an inductive (E = L di/dt) voltage drop of over 100kV for a typical 18kA lightning strike.

With no available tester, the question remains: What is the ground system’s impedance at lightning’s range of frequencies/rise times? Although this impedance is still an unknown, design practices with multiple parallel inductances, such as radials and ground rods, can make a ground system with a faster transient response to quickly disperse lightning’s fast rise time pulses.

GROUND RODS

Ground rods come in many sizes and lengths. Popular sizes are 1/2”, 5/8”, 3/4” and 1”. The 1/2” size comes in steel with stainless cladding, galvanized or copper cladding (all-stainless steel rods are also available) and can be purchased plain (unthreaded) or sectional (threaded). The threaded sizes are 1/2” or 9/16” rolled threads. It is important to buy all of the same type. Couplings look much

like a brass pipe with internal threads and allow two rods to be joined (threaded) into each end.

Theoretically, one ground rod with a 1" diameter driven in homogeneous 1,000-ohm per meter (ohm/meter) soil for one meter would yield 765 ohms. Driving it two meters into the soil would give 437 ohms. Going to three meters, however, does not give as great a change (309 ohms). One would get faster ohmic reduction and easier installation by using three rods, each one meter long, giving 230 ohms compared to that of one rod three meters long. This assumes they are spaced "greater than the sum of their lengths apart". If the bare interconnecting wire is also buried below the surface, then the ground system may be less than 200 ohms. (Having one deep ground rod, 40 feet or more, even if it reaches the water table, will not act as a good dynamic ground because the top 5 to 10 feet will conduct most of the early current rise and could become saturated. Eddy currents will form in this top layer and cause the rod's inductance to impede the flow of current to any further depth.)

GROUND SATURATION

The statement that rods should have a separation, "greater than the sum of their lengths apart," originates from theory, and the fact almost all ground rods will saturate the soil to which they connect. A ground rod connects to localized, irregularly sized, three-dimensional electrical clumps. Depending on the soil make-up (layering, etc.), the volume of earth a ground rod can dump charge into can be generalized as the radius of a circle equal to the length of the rod at the circle's center. This is known as the *sphere of influence* of the rod. The sum of the driven depths of two rods should be, theoretically, the closest that ground rods can be placed. Anything closer will cause the soil (clumps) connected in common to saturate even faster.

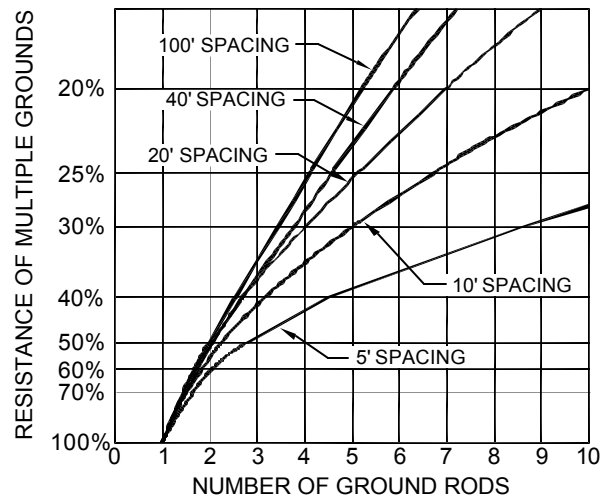

Theoretical resistance change for additionally spaced ground rods.

GROUND ROD SPHERE OF INFLUENCE

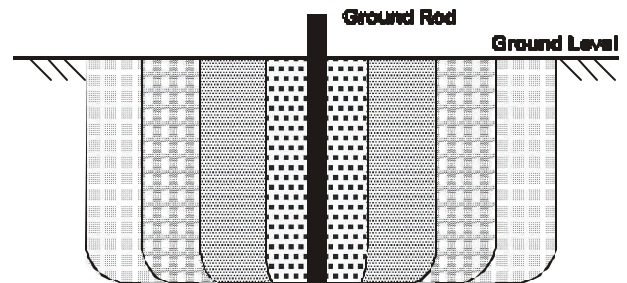

Incorrect Spacing

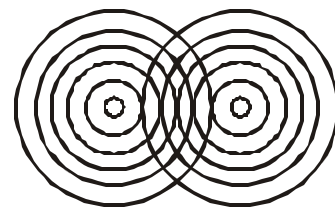

Correct Spacing

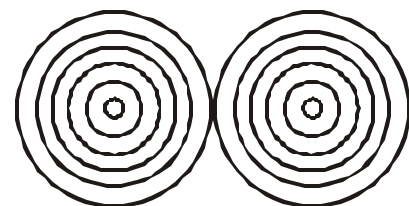

8Ft. Rod - 8Ft. Radius Influence
10Ft. Rod - 10Ft. Radius Influence

A sandy area has a water table at the 10-foot level. Two 10-foot ground rods are coupled and are to be driven to a total depth of 20 feet. A second rod is to be driven no closer than 20 feet to the first, but 40 feet would be according to the "sphere of influence rule. The rule can be looked at two ways:

(1) Only 10 feet of each 20-foot rod is in conductive soil (the top 10 feet of each rod is in non-conductive dry sand), so 10 feet + 10 feet = 20 feet apart.

(2) Without taking the water table depth into consideration, 20 feet + 20 feet = 40 feet.

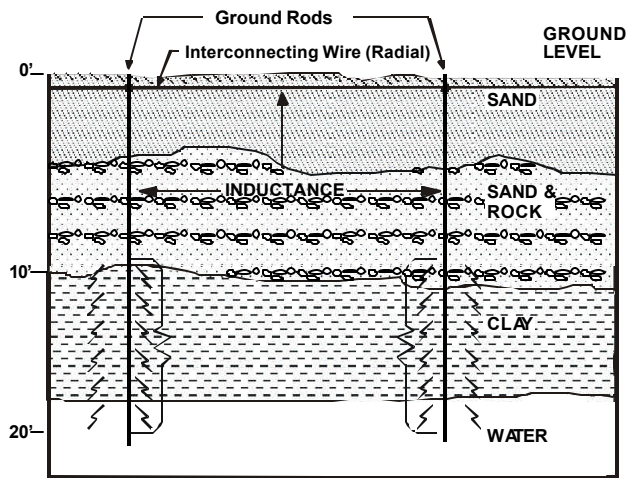

Following the rule, the separation in #2 will not work! The interconnecting inductance will choke off the higher frequency components of the surge's rise time and create an $L \frac{di}{dt}$ voltage drop. Due to the interconnecting inductance, most of the surge will never reach the second ground rod. Following #1's spacing, the inductance will be less, but there are two other solutions to this real life problem. First, using copper strap can reduce the interconnecting conductor's inductance. Second, by using chemical salts to increase soil conductivity around the rods and along the interconnect path, the resistance is also reduced. For the best performance, use both solutions together with #1's spacing.

GROUND SYSTEM INTERCONNECTIONS

As the spacing between vertical ground rods is increased, the interconnecting wire will be able to launch or leak current into the surrounding conductive earth. Therefore, it can be thought of as a horizontal ground "rod" connecting to vertical ground rods. In *highly conductive* soil, one should not be concerned about the inductance of such a straight wire because such a wire acts as a leaky transmission line with very high losses to the soil resistance. Therefore, wire size (skin effect) is of little importance, like that of rod diameter mentioned earlier, as long as it can handle the $I^2 \times R$ of the surge. For *highly conductive* soil, a #10-AWG (bare) is the smallest wire that should ever be used. This type of soil is *not* common.

In areas where soil conductivity is poor, such as sandy soil, the #10 buried interconnecting wire approximates an inductance as if suspended in air. This undesirable condition causes it to be highly inductive, preventing strike current (which has a fast rise time) from being conducted by the wire. Ground rods connected in this way are not effectively utilized.

INTERCONNECTION MATERIALS

Solid copper strap should be used to inter-connect ground rods in poor conductivity soil, solid copper strap should be used. The strap may be as thin as 0.016". For 1-1/2" wide strap, the cross sectional area will equate to a #6 AWG wire. Greater thickness gains only a little advantage because high frequency currents (1 MHz) penetrate only to a depth of about 0.008" per surface, owing to "skin effect". Although the strap width should be about 1% of its length (e.g., 20 feet x 0.01 = 2.4" wide), 1-1/2" strap is usually acceptable.

Connecting the strap to the rod may be done using a clamp. (An exothermic weld is best but not always available, check with your supplier for an appropriate mold or "one shot") For 5/8" rods and 1-1/2" strap, a clamp offers a way to achieve a mechanically rigid, low maintenance connection.

The copper connection must be cleaned and a copper joint compound applied to prevent moisture ingress. Copper clamps that bond straps and rods together in the soil and many other 1-1/2" strap to cable clamps (6AWG to 4/0) are available.

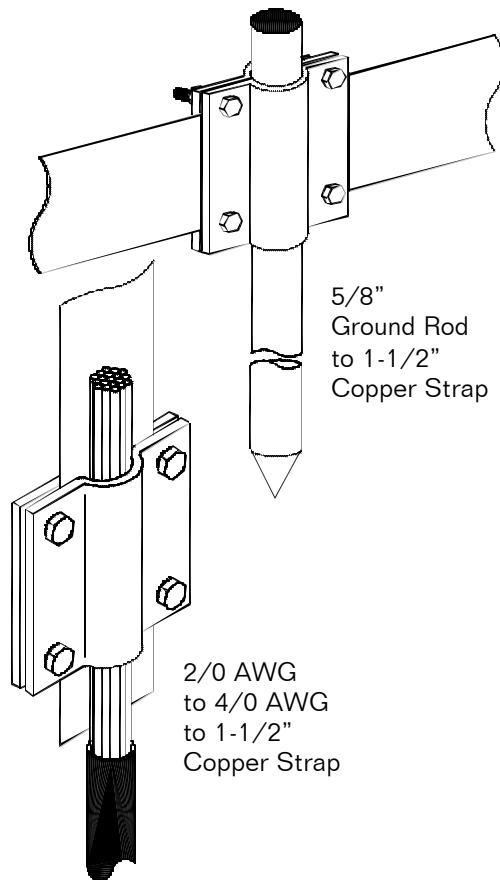

DRIVING THE SECTIONS

Driven rods will out perform rods whose holes are augured or back-filled and not tamped down to the original density. The soil compactness is better around driven rods giving more "connection" to the rod. It will be necessary to purchase a "pounding cap" for hammering threaded rods or a bolt that fits the coupling. By threading the coupling on to the top end of the rod and threading the bolt into the coupling, a "smash proof" hammering point is achieved, saving the rod's threads.

What type and size of ground rod should be used? Most seem to choose the copper clad 5/8" x 8 or 10 feet. The rod diameter should increase as the number of tandem rod sections and soil hardness/rockiness increases. The rod diameter has minimal effect on final ground impedance.

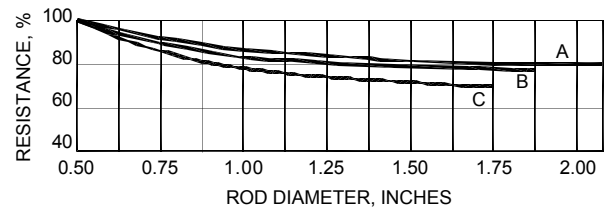

Three individual tests (A,B,C). Each took a 1/2" Ground Rod which was used as a reference and set to 100%. The Rod size was increased and different results are due to ground conductivity variations.

GROUND ROD DEPTH

The total depth each ground rod must be driven in to the soil depends on local soil conductivity. Soil resistivity varies greatly depending on the content, quality and the distribution of both the water and natural salts in the soil. It is beneficial to reach the water table, but it is not necessary in all cases.

In higher latitudes, single rods should be long enough to penetrate below the maximum frost depth. In some cases, a total depth of 40 feet or less is necessary, with the average being 15 feet. *Depth would also depend on the number of rods and the distances between them.*

RF, LIGHTNING, & SAFETY GROUNDS

A single driven ground rod, or one at each leg, is never enough to ground a tower for lightning. The rods will immediately saturate and the local ground potential will rise. There are three types of grounds, each required for different purposes:

- **RF ground**, such as an antenna counterpoise. A ground plane takes the place of the other half of a normal vertical dipole. A good RF ground plane could be elevated above ground (tuned) and thus cannot be a good lightning ground. If such a ground plane is properly extended and placed in the soil, it will no longer be tuned. It can then be used as an RF noise and lightning sink. *Therefore, not all RF grounds are good lightning grounds, but most good lightning grounds are good RF grounds for low frequencies.*

- **Lightning ground.** This ground must be able to sink large amounts of current quickly (fast transient response). The typical frequency range of lightning energy at the bottom of a tower can be from dc to the low VHF range (<100MHz). The ground system must be a broadband absorptive counterpoise over this frequency range.
- Power return or **safety ground** for ground faults. *This is a low frequency (60Hz) ground and may be very inductive to lightning's fast rise time, yet still be usable for 60Hz.*

The signal source for the three-stake fall of potential resistance measurement is a low frequency ac potential, usually around 100 Hz. The electrical safety ground is often not a good lightning ground for that reason.

RADIALS

Some locations are rocky enough that only the horizontal conductors can be placed below grade. Buried horizontal radials, like those used on vertical broadcasting antennas, make an excellent RF and lightning ground system. Theoretically, four radials each 20 meters (m) long, of #10 gauge wire, just buried will yield 30 ohms in 1,000-ohm/meter (ohm/m) soil. Eight radials would give about 25 ohms. Eight radials each fifty meters (163 feet each or 1,300 feet total wire) on top of the ground or hardly buried could give about 13 ohms in 1K-ohm/m soil. Theoretically, by adding 2m long rods (if possible) to this system, one on every radial (8 rods total), would calculate the system resistance below 10 ohms. If the rods were spaced every 10m on each radial (32 rods total), then the resistance would go to about 4 ohms. This is the theoretical *impedance at 100Hz* for 1,000-ohm/m soil, which could be sandy or rocky. *A long radial run will not work as well with a fast rise time lightning current pulse as many shorter radials.*

There is a law of diminishing returns for radials. As with sprinkler hoses, the amount of water, or in this case lightning energy, at the end of a 75' length

radial is so small going further is wasting time, effort, and material. It is recommended radials only have a 75' run (no shorter than 50 feet if possible) and then additional radials from the tower be used to further reduce the surge impedance/ground resistance. The measured earth resistance of the radial system may be decreased, but like ground rods, you will need to double what you have to not quite halve the resistance value. The radial runs should be oriented away from the equipment building as much as possible. In this way, the greatest amount of energy is carried off from the tower and away from the equipment building.

Some have stated "if a radial is like a lossy transmission line, and the energy is not absorbed by the time it reaches the end of the radial, it will reflect back to the tower base." This would seem to indicate there are not enough radials in poor conductivity soil since the soil becomes saturated and will not absorb any more electrons. That is one more reason to install additional radials and rods, not just longer radials.

Since the radial system is emulating a solid plate. The capacitance of this plate to true earth will determine the amount of charge that can be transferred. The resistance will dictate the time constant in which the plate will be elevated (saturated) above earth. Adding more radials with ground rods will increase the surface area (capacitance) and decrease the resistance.

UFER GROUNDS

When building a new site, some radio installations do not take advantage of what is known as the *Ufer ground*. This grounding technique can significantly reduce the overall ground system impedance. The Ufer technique can be used in footings, concrete building floors, tower foundations and guy anchors.

The Ufer ground can be both a good lightning ground and safety ground. Under a ground fault condition, more total energy will be conducted to ground than during a lightning strike, due to the longer time required to clear the fault. Lightning has a very high peak energy, but the duration is

very short. The Ufer has been proven to handle both without failure.

Herbert G. Ufer, for whom the technique is named, worked as a consultant for the US Army during World War II. The Army needed to earth ground bomb storage vaults near Flagstaff, Arizona. Since an underground water system was not available and there was little annual rainfall, Mr. Ufer came up with the idea of using steel reinforcing rods embedded in concrete foundations as a ground. After much research and many tests, it was found that a ground wire, no smaller than a #4AWG conductor, encased along the bottom of a concrete foundation footing, would give a low resistance ground. A 20-foot run (10 feet in each direction) typically gives a 5-ohm ground in 1000-ohm-meter soil conditions.

UFER GROUND TESTS

One of the most important tests performed was under actual lightning conditions. The test was to see if the Ufer ground would turn the water inside the concrete into steam and blow the foundation apart. Results indicated that if the Ufer wire was 20' minimum and kept approximately 3" from the bottom and sides of the concrete, no such problems would occur. *(A Ufer ground should always be used to augment the lightning grounding system and not be used alone. Radials, or radials with ground rods, should be used together with the Ufer. For those who are afraid to use the Ufer, think about this: The heating of the concrete is more likely if the current is high or concentrated in a given area. This is known as current density "J". The more surface area there is to spread out the given current, the less the current density. Your tower's anchor bolts are already in the concrete. If the ground system is poor, the current density surrounding the bolts could be high, turning any ambient moisture to steam, and could blow apart your concrete. If the rebar is tied in to the "J" bolts, the area is increased and the current density is reduced. (Corrosion will be reduced as well.)*

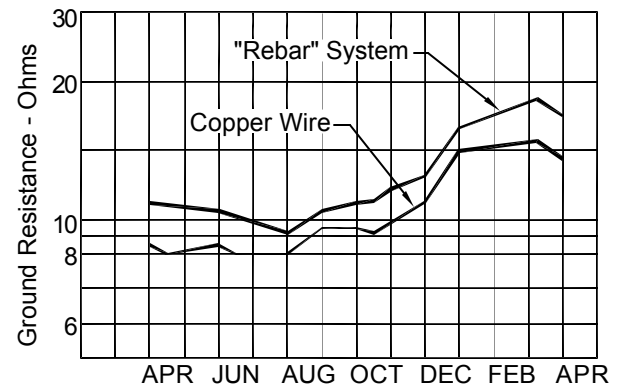

Graph of Rebar Versus Copper Wire

A Ufer ground could be made by routing a solid wire (#4 AWG) in the concrete and connecting to the steel reinforcing bar (rebar). Theoretically, the outermost sections of the rebar structure should be bonded together, not just tied. If tied, a poor connection could cause an arc. Because arc temperatures are very high and are very localized, they could cause deterioration of the concrete (cracking and carbonizing) in that area.

Although possible, this has *not* been the case in practice. The wire ties are surprisingly effective electrical connections. "One might think that the ties would fail under fault conditions. However, it should be remembered that there are a large number of these junctions effectively in parallel, cinched tightly." (IEEE Seminar Notes 1970.)

The use of large amounts of copper cable coiled in the base of the tower (for a Ufer "effect") has been shown to cause flaking of the concrete and could, over time, also cause de-alloying of the rebar. This can occur due to the concrete's pH factor. The use of copper conductors, such as radials and ground rods, outside the concrete, has not shown these problems.

Using a small amount of copper wire, such a radial "pigtail" connection (short run in the concrete) will not adversely affect the rebar during a typical 30-year tower life.

CHOOSING THE LENGTH

The minimum rebar length necessary to avoid concrete problems depends on the type of concrete (water content, density, resistivity, etc.). It is also dependent on how much of the buried concrete's surface area is in contact with the ground, ground resistivity, ground water content, size and length of bar, and probable size of lightning strike current. The last variable is a gamble! The 50% mean (occurrence) of lightning strikes is 18,000 amperes; however, *super strikes* can occur that approach 100,000 to 200,000 amperes.

<u>Conductor</u>	<u>Diameter</u> <u>Inches</u>	<u>Surge</u> <u>Amps/Ft</u>
Rebar	.375	3400
Rebar	.500	4500
Rebar	.625	5500
Rebar	.750	6400
Rebar	1.000	8150

The chart shows how much lightning current may be conducted per foot of rebar for (dry mix) concrete. Take the total linear run of wire and multiply it by the corresponding amperes per foot to find out how long the ground conductor must be to handle a given strike current. Only the outside perimeter rebar lengths of the cage should be totaled.

Protection to at least the 60,000-ampere level is desirable. This offers protection for 90% of all lightning strike events. *A Ufer is only to be used together with a radial, or radial and rod ground system.*

HOW IT WORKS

Concrete retains moisture for 15 to 30 days after a rain, or snow melt. It absorbs moisture quickly, yet gives up moisture very slowly. Concrete's moisture retention, its minerals (lime and others) and inherent pH (a base, more than +7pH), means it has a ready supply of ions to conduct current. The concrete's large volume and great area of contact with the surrounding soil allows good charge transfer to the ground.

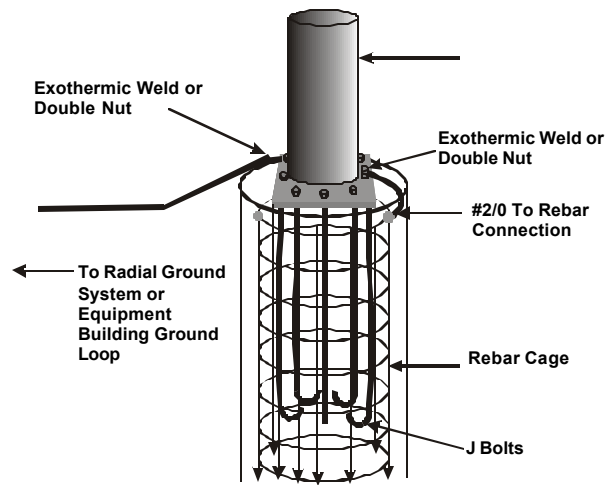

Sample tower base Rebar Assembly with #2/0 stranded copper pigtails used to interconnect Tower Ufer Ground to Equipment Building Ground, Ground Rods, Radials, etc.

MATERIALS

Rods may be clad with copper to help prevent rust, not for better conductivity. Of course, copper cladding is a good conductor, but the steel it covers is also an excellent conductor when compared to local ground conductivity.

The thickness of the copper cladding is important when it comes to driving the rod and when the rod is placed in acidic soil. Penetrating rocky soil can scratch off the copper and rust will occur. Rust, an iron oxide, is not conductive when dry, but it is fairly conductive when wet. In acid ground conditions, such as in an evergreen area, the copper will be attacked. The thicker the copper cladding, the longer the rod will last. Some have elected to tin *all* copper components in an attempt reduce corrosion. Actually, this is not a bad idea. Tin will protect the copper in acid soil. The tin will be sacrificed in alkaline soil, but the copper will remain.

A swimming pool or garden soil acid/base tester can be used to determine the soil pH. Any ground system will need to be checked and maintained on a regular basis to assure continued performance.

ABOUT CORROSION

Corrosion is an electromechanical process that results in the degradation of a metal or alloy. Oxidation, pitting or crevicing, de-alloying, and hydrogen damage are but a few of the descriptions of corrosion. Most metals today are not perfectly pure and consequently when exposed to the environment will begin to exhibit some of the effects of corrosion.

Aluminum has an excellent corrosion resistance due to a 1-nano-meter-thick barrier of oxide film that forms on the metal. Even if abraded, it will reform and protect the metal from any further corrosion. Any dulling, graying, or blackening that may subsequently appear is a result of pollutant accumulation.

Normally, corrosion is limited to mild surface roughening by shallow pitting with no general loss of metal. An aluminum roof after 30 years only had 0.076mm (0.0003 inch) average pitting depth. An electrical cable lost only 0.109mm (0.0043 inch) after 51 years of service near Hartford, Connecticut.

Copper, such as the C110 recommended for Bulkhead Panels, has been utilized for roofing, flashing, gutters and down spouts. It is one of the most widely used metals in atmospheric exposure. Despite the formation of the green patina, copper has been used for centuries and has negligible rates of corrosion in unpolluted water and air.

Joining copper to aluminum or copper to galvanized (hot dipped zinc) steel with no means of preventing moisture from bridging the joint would result in corrosion loss over time. This is the accelerated corrosion (loss) of the least noble metal (anode) while protecting the more noble metal (cathode). Copper, in this example, is the more noble metal in both of these connections. See the Noble Metal Table (below) for a ranking of commonly used metals.

Where the copper connection is with galvanized steel, the zinc coating will be reduced allowing the base steel to oxidize (rust), which in turn will increase the resistance of the connection and compromise the integrity of the mechanical structure. Aluminum will pit to copper leaving less surface area for contact and the connection could become loose, noisy, and possibly arc under load.

	Magnesium	Aluminum	Zinc	Iron	Cadmium	Nickel	Tin	Lead	Copper	Silver	Palladium	Gold
MAGNESIUM	0.00	-0.71	-1.61	-1.93	-1.97	-2.12	-2.23	-2.24	-2.71	-3.17	-3.36	-3.87
ALUMINUM	0.71	0.00	-0.90	-1.22	-1.26	-1.41	-1.52	-1.53	-2.00	-2.46	-2.65	-3.16
ZINC	1.61	0.90	0.00	-0.32	-0.36	-0.51	-0.63	-0.64	-1.10	-1.56	-1.75	-2.26
IRON	1.93	1.22	0.32	0.00	-0.04	-0.19	-0.30	-0.31	-0.78	-1.24	-1.43	-1.94
CADMIUM	1.97	1.26	0.36	0.04	0.00	-0.15	-0.27	-0.28	-0.74	-1.20	-1.39	-1.90
NICKEL	2.12	1.41	0.51	0.19	0.15	0.00	-0.11	-0.12	-0.59	-1.05	-1.24	-1.75
TIN	2.23	1.52	0.63	0.30	0.27	0.11	0.00	-0.01	-0.47	-0.94	-1.12	-1.64
LEAD	2.24	1.53	0.64	0.31	0.28	0.12	0.01	0.00	-0.46	-0.93	-1.11	-1.63
COPPER	2.71	2.00	1.10	0.78	0.74	0.59	0.47	0.46	0.00	-0.46	-0.65	-1.16
SILVER	3.17	2.46	1.56	1.24	1.20	1.05	0.94	0.93	0.46	0.00	-0.19	-0.70
PALLADIUM	3.36	2.65	1.75	1.43	1.39	1.24	1.12	1.11	0.65	0.19	0.00	-0.51
GOLD	3.87	3.16	2.26	1.94	1.90	1.75	1.64	1.63	1.16	0.70	0.51	0.00

← LESS NOBLE →

Noble Metal Table: Accelerated corrosion can occur between unprotected joints if the algebraic difference in atomic potential is greater than ± 0.3 volts.

Using a joint compound covering and preventing moisture from bridging the metals can prevent joint corrosion problems. The most popular compounds use either graphite or copper particles embedded in a grease. As the joint pressure is increased, the embedded particles dig into the metals and form a virgin junction of low resistivity, void of air and its moisture. The use of a joint compound has been adopted as the recommended means for joining coaxial protectors to bulkhead panels for non-climate controlled installations. Copper joint compound is supplied for bulkhead panel ground strap connections. This compound has been tested with a "loose" one-square-inch copper to copper joint, and can conduct a 25,500 ampere 8/20 waveform surge with no flash over and no change in resistance (0.001 Ohms). Moving the loose joint after the surge found no change to its resistance.

The connection of a copper wire to a galvanized tower leg should be avoided even if joint compound is used. The problem is the limited surface area contact of the round wire with the (round) tower leg. Consider using two PolyPhaser TK series stainless steel isolation clamps. The TK clamps will help increase the surface area of the connection and provide the necessary isolation between the dissimilar metals. Use joint compound on exposed applications of the TK clamps. For a more effective connection, use copper strap in place of the wire with one TK series clamp. Other connectors are commercially available where the two dissimilar metals are already bonded together.

Silver oxide is the only oxide known to be conductive. (This is one reason why quality N-type coax connectors are all silver with gold center pins.) Copper oxide is not conductive. The proper application of joint compound will prevent copper oxidation.

If copper clad ground rods are used, be sure the oxide layer is removed. Tinned wire should not be used together in the ground with copper ground rods. Tin, lead, zinc and aluminum are all more anodic than copper. They will be sacrificial and disappear into the soil. It is recommended that all components be made of the same external material (all tinned or all copper).

DOPING THE SOIL

Salts may be added to increase the conductivity of the soil, but it is a temporary solution that must be renewed every year to maintain the elevated conductivity. Chemical ground rods can help capture the precipitation and direct it through the salts, creating a saline solution dispersed into the surrounding soil. It can also be fed from a timed drip system, if domestic water is available.

Chemical additives, such as Rock Salt, Copper Sulfate and/or Magnesium Sulfate, will help reduce the R (resistance) value so some dissipation can occur. (Remember, power is I^2R .) This will dampen the ringing, transform the surge energy into heat and increase the size (volume) of the ground system. The latter two chemicals are less corrosive than Rock Salt. Magnesium Sulfate will have much less of an environmental impact than the other salts. All salts will lower the freezing point of the soil moisture, which is important at higher elevations. About 2 kilograms (kg) of salts will dope 2 meters of a radial run for one year. About 5 kg (minimum) is necessary for each ground rod. Make sure the salts are watered in or they may be blown away.

Encapsulation of radials in conductive gels or carbon materials is an alternative where little or no soil exists. Commercial products are available for this use. Acrylamide gel, Silicate gel, and Copper ferrocyanide gel are listed here in the order of increasing conductivity; however, all involve toxic and/or hazardous materials. An easy alternative is to use concrete to make a Ufer ground.

ON ROCKS AND MOUNTAINS

If soil is rocky enough that radials are sometimes in air while spanning between rocks, the accumulated inductance along the runs will choke off the surge currents. In this situation, numerous slightly shorter lengths of solid flat strap radials have been effective. The copper strap's sharp edge will concentrate the E fields that are present due to the existing $L di/dt$ voltage drop and breakdown or arc onto the surface of the rock or soil.

On solid bare rock, strap arcing will help spread out the charge onto the rock's surface. A strike is usually an onslaught of electrons with like charge. Electrons repel and want to spread out. In doing so, they lose energy due to the resistances involved. Since little conductivity is present on dry bare rock, there will be little spreading in the time frame of a strike. If rain occurs before the event, then the surface of the rock will be quite conductive and the charge will spread out, losing energy in the process. The more it spreads, the more energy is lost as the charge density is reduced. The use of the Ufer ground technique at the tower base and at the guy anchors will help spread the charge.

Be aware that low-frequency ringing may occur since the entire grounding scheme is being excited. Think of such a site as a giant vertical (parasitic) antenna being excited by a broadband (arc) noise generator (the lightning strike). The ringing will further stress the I/O surge protectors, such as the power line and telephone line protectors.

A MOUNTAIN TOP “NON-RESONANT COUNTERPOISE”

By placing several copper straps in the soil or on the rock, a counterpoise is created much like those used on AM broadcast tower sites. Even though the mountain is an insulator, the radials charge up like a capacitor and spread out the charge onto the surface. The sharp edges of the strap will help breakdown the air and form arcs onto the surface of the rock.

This action will not affect the equipment and is beneficial, since like arcing in the soil, it will reduce the elevated potential of the entire ground system. We are still dealing with a theoretical antenna (the tower) and a ground plane (the radials) which can “ring” when excited by an arc. *Random lengths cut to odd multiples/divisions of the tower height are recommended as part of the circuit to reduce the possibility of “ringing.”* Increasing the rock's surface conductivity will dampen and dissipate the strike energy. This may be as simple as having light rain just before the strike event.

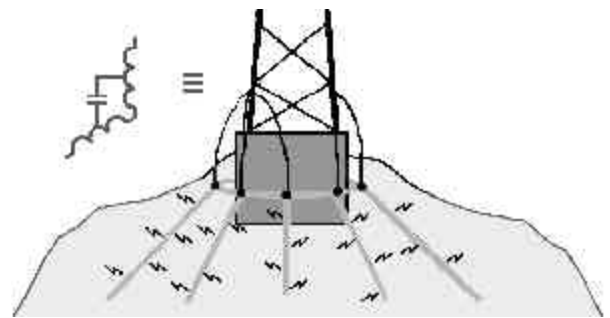

A Non-resonant Counterpoise

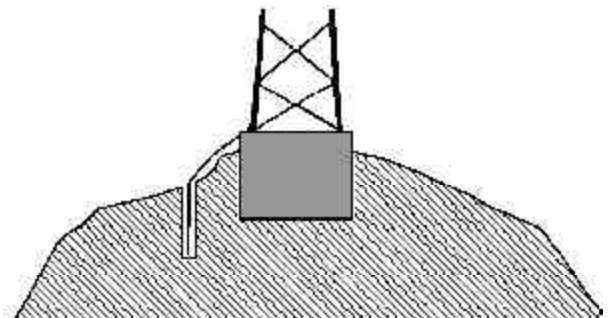

Drilling and backfilling a single ground rod not recommended without additional grounding components.

Avoid the concept of drilling holes in a mountain top and filling it with conductive material (a “conductive hole?”). Most mountain locations do not have fissures in the rock which allow water to collect, making the fissures conductive. (A consultant in South America recommends setting an explosive charge in the bottom of such a hole to “fissure” the rock. Consider this at your own risk!)

Solid rock is not going to be any more conductive in a hole than on the surface. Consider what happens in the hole after it has some electrons in it? Since the electrons repel one another, few will enter the hole. Like water, the electrons will spill on to the surface of the rock and spread out. Unlike water, the repulsion of electrons will mean fewer are needed to fill the hole and, once filled, the spreading on the surface will have an added force. The best way to disperse the electrons is by having a radial ground system. Commercial products are available to encapsulate the radial in a conductive concrete-like substance.

Ground Impedance

Before one can design a properly sized grounding system for the required fall of potential measurement, the resistivity of the soil must be known. The resistivity results will determine the conductor size, length, and number of radials required. The measurement will also determine how many rods are required, their length, and their spacing on each radial.

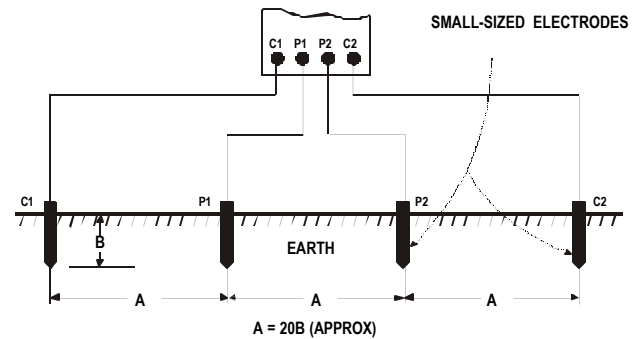

Four stake method of measuring soil resistivity.

MEASURING YOUR SOIL

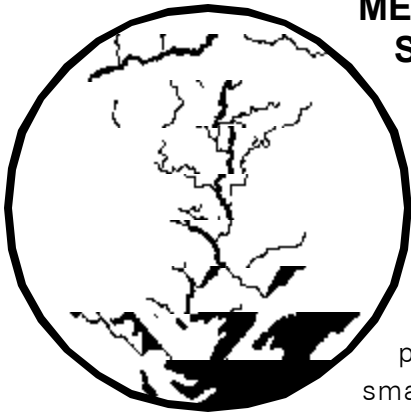

A method for determining mean value of soil resistivity (ρ_E) is shown. Four equally spaced electrodes are driven to a shallow depth; the penetration depth (b) is kept small in comparison to the inter-electrode spacing (a) where $(a) \geq 20(b)$. A known AC current is circulated between the two outer-electrodes while the potential is measured across the inner pair. The tester will provide an indicated resistance in Ohms (RE). If the electrode spacing (a) is in meters, use the formula to convert to rho (ρ_E).

$$\rho_E = 2\pi a \cdot RE$$

This gives the mean value of soil resistivity (ρ_E) in Ohm-m. The electrode spacing (a) corresponds to the depth of soil seen by the test current. By varying the electrode spacing, a profile of resistivity versus depth can be obtained. The results can be in Ohm-m or Ohm-cm and are “plugged in” to other formulas determining the size and configuration of the copper electrodes in the grounding system.

MEASURING THE GROUND SYSTEM

There is no substitute for an actual fall of potential measurement on a ground system. Most measuring techniques and instruments are similar and have similar faults. Present techniques utilize equipment with steady state dc or (more often) low frequency AC current source waveforms. Neither comes close to simulating the dynamic surge conditions (such as lightning) where inductive voltage drops are developed. Problems would be minimized if multiple parallel inductances (radials with rods) were incorporated in the design and layout of the ground system. Multiple parallel inductances lower the overall system inductance, improve the transient response of the system, and reduce ground potential rise during a lightning “event.”

Another way to obtain a profile of the soil is to measure a ground rod as you hammer it into the soil. If no other ground conductors are present, in or along a 100-foot path, a fall of potential method (3 stake) measurement can be set up before a

ground rod under test is inserted into the ground. The low frequencies used in most testers do not take into account any inductance which may exist in a ground system such as a rod penetrating a sandy layer. The best way to determine the consistency of your underground soil layers is to perform a preliminary fall of potential method measurement and log the readings for each foot that a ground rod is driven. Plotting it should approximate the Relative Earth Resistivity Curve shown below. Any large variation could mean water/clay or sand/gravel. With this knowledge, a better ground system can be designed for the RF properties of the lightning strike.

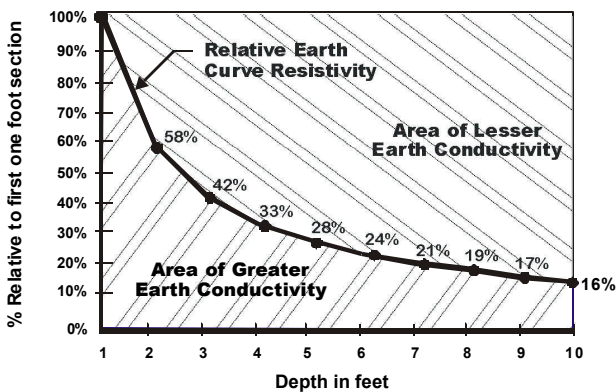

Most sites have a grounding system, but it is usually an unknown. The ground system is considered an unknown because it has never been measured or if it was measured, it has probably changed over time. The soil resistivity varies through out the year because of seasonal moisture and temperature changes. Ground system maintenance must be performed to keep it in operating condition.

Ground systems composed of copper and zinc are quickly eaten away in acidic soils; yet are stable in the presence of alkaloids like concrete. Only aluminum is unaffected by acidic soils, but it is etched by alkaloids. Soil's conductivity is determined by its water and salt content. The more salts, the less water is required to reach a specific conductivity. At least 16% water content, by weight, is required for a soil to be conductive.

Gypsum is better than bentonite and can be added to the soil. Gypsum absorbs and retains water and doesn't shrink/pull away from the conductor when drying like bentonite. Adding 5% by weight, of epsom salts will further insure moisture retention and conductivity.

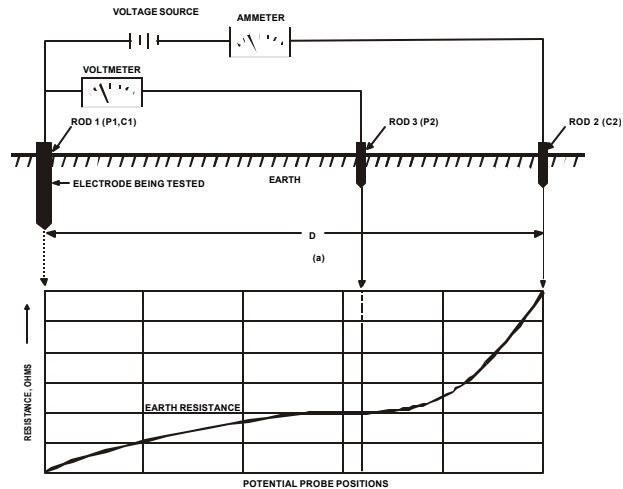

The three stake method, also known as the Fall of Potential Method, is shown and is used to measure the resistance of a *single ground rod*. This can be done on any four stake tester by tying P_1 and C_1 together. The initial spacing between electrodes P_1 , C_1 and C_2 for a simple electrode would be approximately 100 feet, while for an entire grounding system it could be 1,000 feet. The actual spacing may be increased or decreased depending upon the size of the grounding system being measured and the results of moving electrode P_2 .

The goal is to move electrode P_2 at discrete intervals along a line between electrodes P_1 , C_1 and C_2 and record/plot the voltage measurement. It is necessary to locate the area of the curve where moving electrode P_2 has little or no affect on the measured voltage, usually at 61.8% of distance between P_1 , C_1 and C_2 . Most modern instruments convert voltage readings directly to ($R = E/I$) Ohms. (Impedance if an AC current source.)

SURGE IMPEDANCE (Z)

In IEEE Transactions on Broadcasting, Volume BC-25, No.1, March 1979, it was established that radials, together with rods, show a lower dynamic surge impedance under real lightning conditions than the resistance measured at or near dc. This results from a lightning induced ground saturation causing localized arcing and creating a momentary low impedance path between ground masses. The effective area or size of the grounding system is thereby briefly increased. The arcing occurs since any ground system, no matter how good, will momentarily elevate above the global earth potential. This temporary elevation may be due to a slow propagation of the surge through the earth and is measured as the velocity factor and time constant of the ground system. Obviously the larger the impulse, the more arcing and the lower the dynamic impedance. *It has been shown, that the lower the measured impedance using the dc or steady-state low frequency ac type instruments, the smaller the difference will be between the measured and the real dynamic impedance.*

GROUND PROPAGATION

As in any medium, a dynamic pulse, like RF, will take time to propagate. This propagation time will cause a differential step voltage to exist in time between any two ground rods that are of different radial distances from the strike. With a ground rod connected to the base of a tower, the lightning impulse will ideally propagate its step voltage outwardly from this rod in ever-expanding circles, like a pebble thrown into a pond. If the equipment building has a separate ground rod and the power company and/or telephone company grounds are separate still, the dynamic step voltage will cause currents to flow to equalize these separate ground voltages. If the coax cable is the only path linking the equipment chassis with the tower ground, the surge will destroy circuitry while getting through to the telephone and power grounds. (See single point ground system.)

Tower Top, Pole-Mounted, & High-Rise Communications Sites

Tower top protection requirements can be divided into two categories: *preamplifiers* and *repeater/amplifiers*.

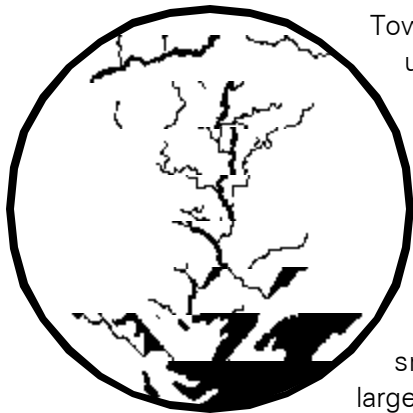

Tower top preamps are often used to obtain a lower receiver system noise temperature (better signal-to-noise ratio) and overcome coaxial cable or multi coupler losses. A cost comparison must be made between a preamp and small coax versus a much larger lower loss coax. The ice and wind loading factors for the tower would also be a consideration.

To keep the number of wires to a tower top preamp at a minimum, dc power is often injected onto the coax cable center pin with the shield as the return. When a dc grounded (shunt-fed) antenna is used and the preamp is physically located on the tower at the same height, with just a short length of coax to the antenna, the series impedance differential between the center conductor and shield is minimal. Some commercially made preamp systems incorporate interdigital front end filters which are dc grounded and act as a front end protector. Preamp front end damage probability with the above conditions is greatly reduced.

PREAMP PROTECTION

Lightning damage is usually to the output circuitry of the preamp. During a strike, the tower, acting as an inductor, creates an instantaneous voltage drop from top to bottom. Since the preamp housing is attached to the tower, it will rise to the same potential as the tower. However, the center conductor on the downward going coax cable from the preamp output has not yet been elevated to tower potential. It can achieve this elevation two ways:

- Internal chassis grounds elevate and pass surge currents through output circuitry to the yet unelevated center conductor. Output circuitry can be destroyed in the process.
- The coax cable shield, grounded to the tower at the top, center, and bottom, will share the surge current with the tower and will couple surge energy (both E and M fields) to the center conductor.

Lightning surge currents from both sources will propagate through the coax shield and center conductor with different speeds and amplitudes toward the equipment. Unless application matched protectors are installed at the top and the bottom of the coax feeder, damage to preamp output and equipment input circuitry can occur. Coax cable series impedance differential can be reintroduced if the equipment in the building is located some distance from the entry port. An additional protector would be required at the equipment input port.

RF AND DC SEPARATE

The surge generated on the shield travels toward the equipment building where it finds a dc injector that combines the dc and the RF. The surge will penetrate through the injector to the dc power supply, causing it to fail to the source voltage.

If the dc power supply has an SCR over voltage crowbar or protector, the dv/dt action of the SCR crowbar will be coupled back through the dc injector and onto the coax cable. It forms a broadband step waveform, exciting the coax line. The line probably does not have a 50 ohm terminating impedance for these lower frequencies at the preamp pickoff end. (The preamp impedance is 50 ohms only in its operating bandpass.) This reflected waveform could reach hundreds of volts at the preamp. The voltage amount depends on the waveform, coax length and the preamp (and "bias T") impedance.

Even if a dc continuity type coax protector was installed with a dc turn on of 90 volts, it would be ineffective. With a power supply voltage of 15 to 48 volts, neither the preamps nor the power supply could withstand the dynamic voltages necessary to turn on this type of protector. (A 90-volt gas tube won't fire until approximately 700 volts under dynamic rise times.) Even if fired, the power supply would feed the arc until a failure occurred.

A SOLUTION

One way to solve this problem is to make a protector that separates the RF from the dc, protects each, and recombines the two together all in the same enclosure.

Even with an injector and pickoff combination, the surge current must enter the equipment building and go to the rack before it can be taken back out to the perimeter ground system. A "pick-or" installed at the bulkhead or MGB decouples the dc from the rf, protects both, and recombines them on the center conductor. The protector is system transparent and allows users of bulkhead panels to prevent almost all the surge current from ever entering the building. An exception would be

an injector located at the bulkhead or MGB with dc inserted there.

The duplexing (combining) of the preamp's output with multiple transmitters on one line reduces coax cost and tower loading. At 800MHz and above, multi-channel lightning protectors for transmitters and receivers, with individual dc injectors, pick-off, and bi-directional pick-ors are available.

REPEATERS, POWER AMPLIFIERS & MICROWAVE LINKS

For tower top repeaters and amplifiers, the I/O's are the most important to protect. Telephone and control lines are often overlooked. Each I/O, tower top and bottom, must be individually protected with an appropriately rated protector referenced to the local and single point ground. Power line protectors (ac or battery dc) must be local and single point grounded at the top and bottom with the equipment. The coax line protector on the preamp's antenna side may be eliminated if similar conditions exist as previously stated for the preamps front end.

Above 18GHz, microwave equipment usually has a downconverter (to an intermediate frequency) located on the back of the dish, powered through one or two coax cables. This line(s) also handles the uplink and downlink frequencies as well as AFC (Auto Frequency Control) error information. Protectors are available and, like the tower top preamps, it will take three locations, tower top, building entry, and equipment rack, to properly protect the system.

Whether a tower, high-rise building or water tower installation, the "single point ground" concept should be carried throughout the grounding scheme. All I/O protectors must be tied together on a grounded plate or equivalent near the equipment. It doesn't matter that the equipment will be a few hundred thousand volts above true earth ground. In these installations it only matters that a ground to the supporting structure exists, so everything will rise and fall in potential together with the strike. Protectors will prevent equipment

damage by allowing survivable voltages on the I/O's relative to the equipment's chassis.

GROUNDING ROOF-MOUNTED ANTENNAS

Antennas on parapet walls or building tops should use the building's structural steel or existing lightning protection system downconductors. The methods discussed below can be utilized with a single point ground design. Elevator shafts used to be a grounding means, but with micro-processors on board, a diverted strike could be costly!

HIGH-RISE BUILDINGS

The same single point grounding concept, previously discussed, will work for high-rise placed equipment. Tall buildings usually are steel-framed so grounding is reduced to finding a convenient location to ground the single point ground panel to structural steel. If the building has no structural steel, locate the equipment room near a vertical utility corridor. A utility corridor is a vertical shaft that runs the height of the building. Find a *conductive* water pipe or route a large copper strap or 750 MCM cable to the basement. A separate direct ground connection is made in addition to the normal power safety ground. This will provide a good ground path for the surge energy. Single point grounding is the only way to protect your equipment inside the room.

If none of the above options can be utilized, consider finding and attaching to reinforcing bar in the concrete. In some countries this is an accepted way of grounding when there is no structural steel. With literally thousands of interconnections between rebar bundles incased in concrete extending down toward the concrete footers, a good earth connection can be assured.

The single point ground is a "Main Ground Bar" (MGB) installed on a vertical structure near the equipment. All coaxial cable ground kits, cable trays and the neutral (X0) terminal of the isolation transformer (if used) are bonded to this MGB. This MGB should be bonded to one or more of the

following four options. High-rise building grounding options, in order of preference, would be:

Structural steel will absorb a portion of lightning's fast rise time pulse, distribute the energy through the steel building members, and provide a low inductance path to the building footings and earth. The overall *time* the equipment would be subject to high potentials, referenced to the outside world, would be minimal.

Concrete-encased steel reinforcing bar will absorb a portion of lightning's fast rise time pulse, distribute it throughout the structure, and provide many parallel conductive paths to the building footings and earth ground. The overall *time* the equipment would be subject to high potentials, referenced to the outside world, could be slightly greater than a building with structural steel.

A large steel water pipe will absorb less of lightning's fast rise time pulse and come up to a higher potential, referenced to the outside world, more quickly and stay there longer than either of the above two methods.

A single "Down-Conductor" from rooftop to an external ground rod(s) is unfortunately the way many high-rise sites are connected to earth. In this case the grounding conductor is essentially "suspended in air" and the inductance of the conductor rises to its "free space" value. A fast rise time lightning pulse creates a rapid rise to peak potential, referenced to the outside world, and stays there for an extended time until the down-conductor has time to *drain* away the charge.

The magnetic field formed around the single current-carrying conductor in free space immediately impedes the flow of electrons toward earth. Since the magnetic field is sustained by current flow from the high rooftop potential, it will limit the current-carrying ability of the down-conductor until the charge has been almost entirely drained .

The more time the rooftop equipment is exposed to a high potential, referenced to the outside world, the more possibility there is of damage. Single point grounding techniques and appropriate protectors are imperative to survival!

Coaxial Cable Lightning Protectors

Antenna manufacturers utilize shunt-fed dc grounded antennas as a means of impedance matching and providing some form of lightning protection to their customers. It has been proven that these antennas do work and should be used as a means

of diverting a portion of the direct strike energy to the tower and its ground system.

Unfortunately this protection is designed to help the antenna survive and not the equipment. A direct hit, or even a near hit, can “ring” an antenna whether it is grounded or not since it is a tuned (resonant)

circuit. The ringing waveform will contain all resonances that are present in the antenna and its coax phasing lines. This means both “on frequency” ringing and other frequencies present will be propagating down the transmission line towards the equipment. The “on frequency” energy will not be attenuated by a high Q duplex filter or a 1/4 wave grounded stub being used as a protector. In both instances, the “on frequency” energy will pass right through. Also, if we look at a typical dc grounded/shunt-fed antenna at the top of our 150-foot tower example, both the center conductor and shield will be at the same 243kV potential above ground at the antenna feed. Although the grounded antenna will help prevent arc over of the transmission line, it will have a 6kA peak current traversing its length. The same parallel tower segment will have 12kA. The shared strike current, between the tower and the coax, will contain mostly low frequency components.

The lack of high frequency components is due to both the grounding of the antenna and the inductance of the tower/coax, which acts as a “filter.” The antenna ringing voltages, with much higher frequencies, will ride on top of these lower frequencies towards the equipment. A non-grounded antenna will arc over between center pin and shield, creating major high frequency components that will traverse the transmission line to the equipment.

If the coax line were left unterminated as it reaches the master ground bar, the coax could arc over the center conductor to shield even if a grounded antenna were used. This is due to the difference in series impedance at lightning frequencies between the shield and center conductor and the additive ringing voltage. It is important to eliminate or stop this energy from being delivered to the equipment. Since coax lines are rarely left unused, (especially connected to an antenna) these voltages will be converted to current either by a dc continuity coaxial cable arrester, a shunt fed cavity, or by arcing over dc blocking capacitors inside the equipment.

Contrary to popular belief, lightning energy does not “disappear” in the arrester/protector box. Simply connecting a protector in series with the coax line and expecting protection from a strike is wishful thinking. Only a properly installed and grounded coax center pin protector can offer any measure of equipment input protection.

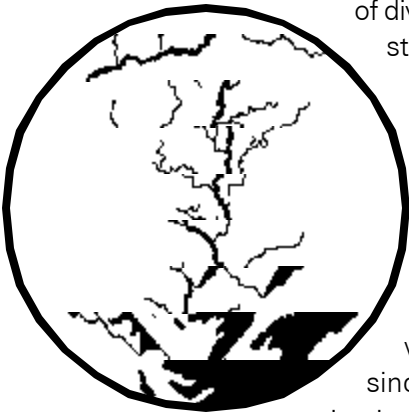

THE NEED FOR PROTECTION

Skin effect is a physical phenomenon that relates to the limited penetration into a conductor of an RF signal, according to its frequency. This effect is present in coax cable, keeping the RF signal inside and any coupled outside interference on the shield's outer surface. The effect begins to fall apart as the frequency is lowered and the penetration, which is a gradient, begins to mix the shield's outside interference energy with the desired inside energy. A ground loop, which imparts 60 Hz onto a desired signal, is causing ac current flow between ends on the coax shield due to dissimilar ground potentials and is low enough in frequency to couple energy through to the center conductor.

With lightning, the main frequency range is dc to about 1 MHz (-3dB). This is in the range that affects the coax transfer impedance. The thicker the shield material, the less the effect of these low-frequency currents.

A test was performed on 50 feet of LMR1200 (7/8") coaxial cable typically used as a feeder. The center conductor and shield on the surge side were shorted to simulate a shunt-fed antenna. The current from the resulting voltage drop across two 0.001 Ohm current viewing resistors at the far end of the cable was viewed using an HP-54522C Oscilloscope. The coaxial feeder assembly was pulsed with a Haefely P surge generator with PHV 30.2 combinational waveform plug-in module. The surge generator was set for a combinational waveform output of $1.2 \times 50 \mu\text{Sec}$ at 6kV open circuit voltage and $8 \times 20 \mu\text{Sec}$ at 3kAmps short circuit current (in accordance with IEC 1000-4-5 and IEEE C62.41 specifications). The peak output voltage and current indicated on the Haefely were 4300 volts and 1750 amps. (See Figure 1.) The resulting peak currents on the shield were 1531 Amperes positive and 688 Amperes negative. The currents on the center conductor were 234 Amperes positive and 63 Amperes negative. Both the shield and center conductor returned to pre-surge levels within 2 oscillations. A slight propagation delay was noted on the center conductor's peak current referenced to the shield peak current.

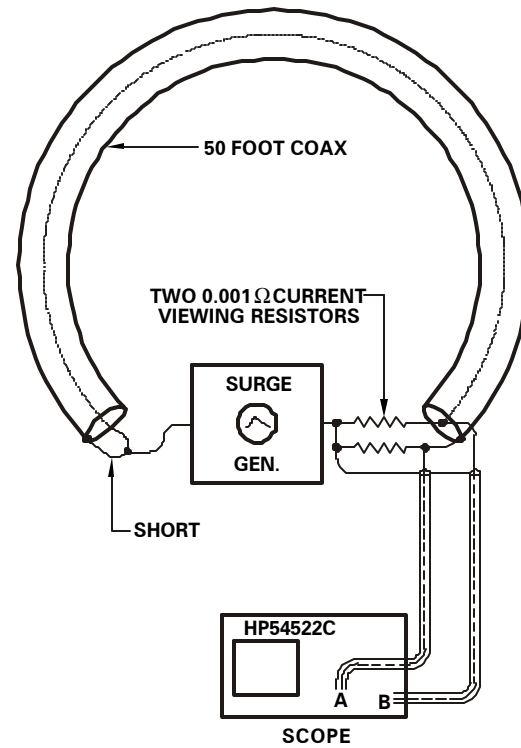
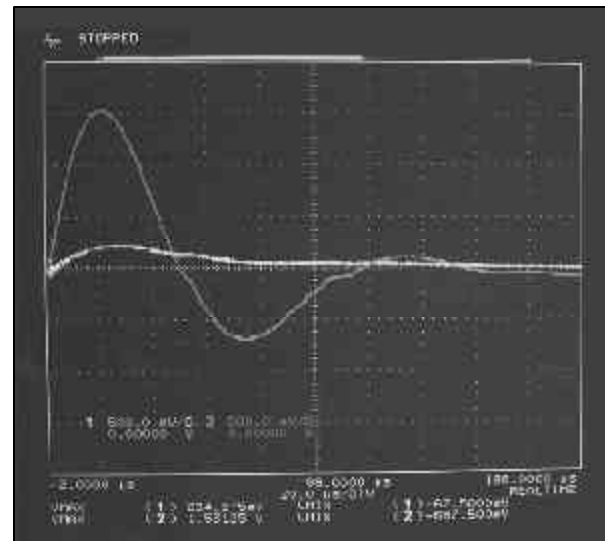

Figure 1



The above pulse was used on a 50' long, 7/8" coax feeder. One end was shorted to simulate a shunt-fed antenna, while the other end went to separate 0.001 Ohm current viewing resistors.

The same test was performed on 6 feet of LMR600 (1/2") coaxial cable typically used as a jumper. The jumper assembly was pulsed with the same combinational waveshape. The Haefely indicated peak voltage and current outputs were 1020V and 2940A respectively. (See Figure 2.) The resulting current on the coax shield was 1875 Amperes positive and 563 Amperes negative. The current on the center conductor was 969 Amperes positive and 156 Amperes negative. Both the shield and center conductor returned to pre-surge levels after 1 oscillation. A slight propagation delay was noted on the center conductor's peak current referenced to the shield peak current.

Figure 2

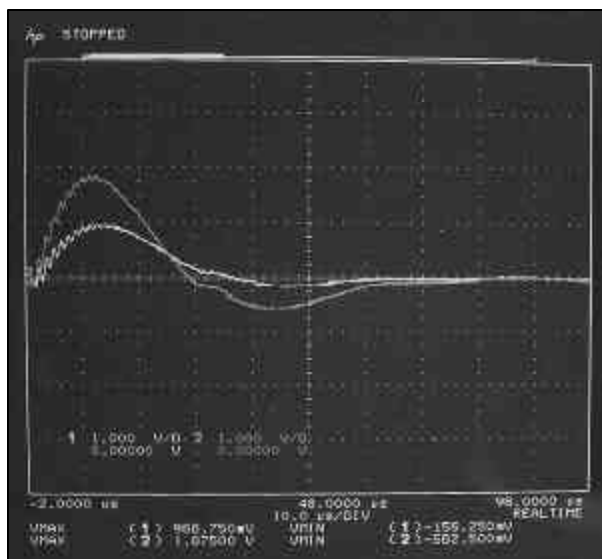

A six-foot-long 1/2-inch coaxial jumper cable with the same pulse applied as in Figure 1.

We should not be surprised by the above results. After all, even the manufacturer calls coax "unbalanced cable!" The current rise time at the top of a feeder coax attached to a tower would be much faster, perhaps 1 or 2 μ S during a lightning strike. The differentials between shield and center conductor with a faster pulse rise time would be much higher. Since lightning frequency pulses travel through both the different impedances of shield and center conductor, the larger circumference shield will have lower inductance, therefore a faster

current rise time than the center conductor. Since the pulses arrive through different impedances, a differential voltage would occur across the shield and unterminated center conductor.

In the first example, using a 50-foot length of feeder coaxial cable, the positive peak differential between the center conductor and shield currents was 1297 Amperes, and the negative peak differential was 625 Amperes. If terminated to a capacitively coupled circuit (high impedance at lightning frequencies), the center conductor voltage would quickly rise and "arc through" the equipment input back to shield potential. If terminated in an inductively coupled circuit (low impedance at lightning frequencies), current flow on the center conductor would continue through the inductive coupling "loop" back to shield potential. High peak current flow through the input circuit could destroy the input connector, the coupling "loop," and continue through to the next stage(s). *Obviously, this pulse differential must be equalized and prevented from entering the equipment!*

A coax cable center pin protector could be considered a very fast voltage sensitive (gas tube) or frequency discriminate (filter) switch. When a given threshold voltage is exceeded for a gas tube type protector, the protector "switches" the energy from the center conductor to the shield (ground). When a filter type protector sees the lower lightning frequencies (out of its passband), it directs them to the shield (ground). In both cases equalization occurs between the center conductor and the shield.

DC CONTINUITY ARRESTORS SHARE LIGHTNING SURGE WITH EQUIPMENT

Lightning arrestors with dc continuity, such as an air gap, simple gas tubes, and 1/4 wave shorted stubs, cannot divert this strike voltage differential without sharing some of it with the equipment. This "sharing" for dc continuity coaxial gas tube arrestors occurs during the time period between zero volts and when the threshold for turn-on has been achieved. Expect a short, high-voltage "spike" to occur at the output before the gas in the tube has time to ionize and become conductive (a short duration 700 to 1kV peak occurs with a 3kA, 8/20 μ s waveform test pulse, and the arrestor output connected to a 50 ohm load. See Figure 3). This high peak voltage goes to the equipment causing arcing, degrading capacitive inputs, or creating damaging current flow in shunted inputs.

Figure 3

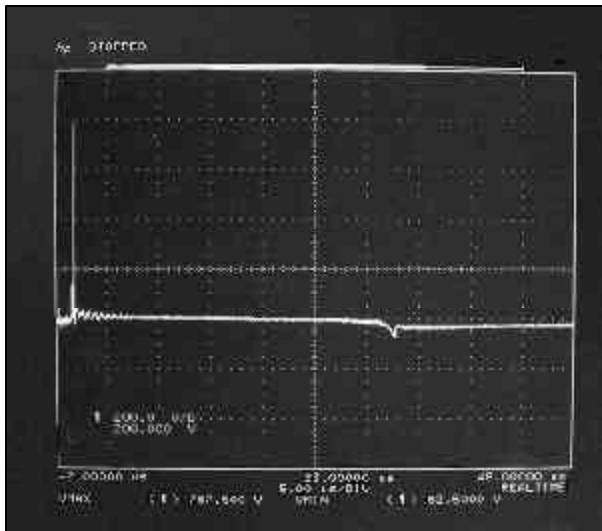

Non dc blocked gas tube protector. Observe 788 Volt peak pulse before gas can ionize and become conductive. This voltage could be applied directly to the equipment input.

For 1/4 wave shorted stubs, from 2GHz and down, the inductance of the stub will still allow considerable voltage to be presented to the equipment input. (+6Vpeak, -2Vpeak ringing for the entire test pulse waveform measured for a 1900MHz 1/4 wave stub with a 3kA 8/20 μ s test

waveform and the stub output terminated to a 50 Ohm load. See Figure 4.) This is due to its inherent L di/dt inductive voltage drop, along with perhaps making the on-frequency antenna ringing voltages greater, because of its own high Q ringing. A higher peak voltage will be present if the equipment has internal capacitive coupling to the center conductor of the coax line. If it doesn't, (e.g., a shunt-fed repeater duplexer) the lower frequency voltages are immediately converted to a current. In this case, dc continuity type arrestors would be relatively useless in *stopping* the surge current since the gas tube arrestor would not turn on in time and the 1/4 wave stub would share surge current with the equipment.

Figure 4

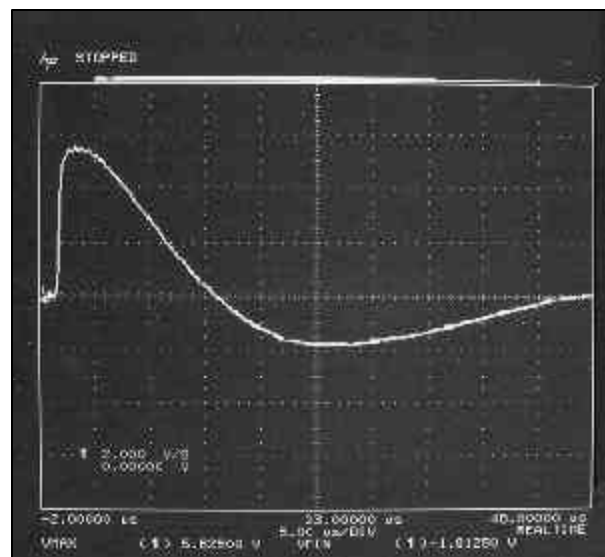

Quarter wave stub. Much lower peak to peak voltage than gas tube (8 Volts peak to peak), but much longer duration. Total energy delivered to equipment input dependent on strike event duration.

DC BLOCKING IS THE ANSWER

PolyPhaser's dc blocked filter type arrestors (see Figure 5), when tested with the same pulse in the same configuration as described above, will typically let through less than 500 milli-volts peak for less than 10 nanoseconds!

Figure 5

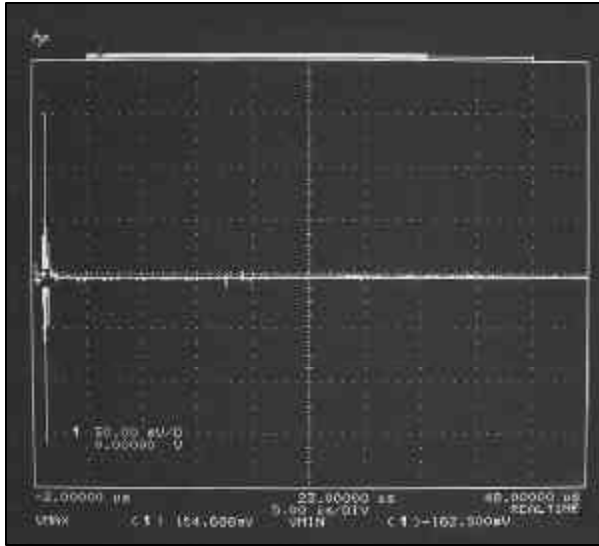

Dc blocked filter type protector lets through only 0.318 Volts peak to peak for less than 10 nanoseconds.

SURGES DAMAGE DUPLEXERS AND ISOLATORS

Not all duplexers have shunt feeds, but those that do can handle some of the lower frequency lightning surge current if properly grounded. It depends on the length of the cavity (frequency band), the size of the shunt-fed loop and its rigidity. (It is really best to prevent the lightning energy from ever entering the equipment building, let alone the equipment itself.) Large magnetic fields can be generated in the duplexer that can bend the loop, de-tune the cavity, and allow even stronger magnetic fields to exist in subsequent strikes. The strike can also weld the cavity input connectors together so the coax line cannot be removed. The "on-frequency" antenna ringing can create large voltages inside the cavities and cause internal arcing. If the first piece of equipment seen by the incoming low-frequency coax surge is an isolator, with each strike (if it survives) a gradual increase in insertion loss will occur due to the surge current's magnetic field re-orienting the isolator's magnetic field, and/or changing the magnet's flux density.

THE BEST PROTECTOR

The most effective type of lightning arrestor is "dc blocked." There is no center conductor continuity from connector pin to pin. This internal capacitive coupling prevents the sharing of low-frequency surge current with equipment and limits the throughput energy to an amount that can be coupled only by the electrostatic field in the capacitor. This allows the dc blocked gas tube type "Impulse Suppressor" to fire as the voltage reaches the turn-on threshold.

PolyPhaser has given considerable attention to the gas tube design to insure that, when transmitting, the RF power will not keep alive the gas in the tube after a strike. Many other protectors, even those licensed by our patent, use a type of gas tube that will not extinguish properly. The transmitted energy continues to excite the tube which becomes a broadband noise generator and will burn up unless transmit power ceases.

Some arrestors use an internal grounding coil designed to drain any coax voltage build-up. (There would not be any, if a dc grounded antenna were used.) The coil is in parallel with the gas tube and does not help filter higher frequency components like antenna ringing, etc. This type of design uses a simple gas tube and has the gas tube extinguishing problem.

An additional problem of this design is the coil, which has added insertion losses, resonances and is wound on a ferrite torrodial core. When a hit occurs, the coil's magnetic field orients the domains of the ferrite core and degrades the inductance value of the coil, causing further RF losses with each successive hit. (Over 90% of the strikes are of the same polarity, so the effects of repeated hits are cumulative to the ferrite core.) PolyPhaser uses only air core coils where they are required. The coils carry a very small inductance and create a low $L di/dt$ voltage drop.

If a grounded antenna can't be used and voltage does build up, it will not get to the equipment. As the protector reaches threshold for turn-on in a dc blocked circuit, it will go into a momentary soft

turn-on as the gas barely ionizes and bleeds the static charge to ground. This does not create noise since it will not get to the arc mode and lasts only a short time.

Have it both ways! A dc blocked rf path, *with isolated and protected low-voltage injector, pick-off, or pass-through ac/dc for tower top powered devices.* A series of protectors designed for receive-only from 50 MHz up and power handling transmit/receive protectors from 800 MHz up are available. This could be a “bias T” replacement that includes rf and dc protection.

Filter Type Protectors. A laser-cut spiral inductor on the surge side effectively grounds the dc and low-frequency lightning components, while allowing the desired frequency range to pass through a flat plate series capacitor to the equipment side (dc blocked, low “Q”, wide bandpass). Product frequency ranges (at this writing) are from 800 MHz to 6 GHz, with ranges and bandwidths designated by model number.

Intermodulation. Careful attention should be paid to intermodulation distortion specifications on all coaxial products due to increased equipment densities and closer frequency assignments at Cellular and PCS sites. Peak power requirements are considered to assure adequate “headroom” for digital modulation techniques.

Intermodulation problems due to non-linearity have always been a problem. With increasing demand for mobile communications, the need for greater channel capacity and more sensitive receivers has made Passive Intermodulation Distortion (PIM) more of a problem than ever. There are many causes of PIM in a communications system. One that directly affects coaxial protector products are connectors and connections to them. The following list was compiled from several articles on PIM:

- Restrict connector materials to copper and copper alloys.

- Connector body plating of silver or white bronze with a minimum plating thickness of $6\mu\text{ m}$ (0.0002”).
- Avoid use of stainless, nickel, or ferrite in signal path. Use gold center pins.
- Quality machining - minimum finish of .4 mm.
- Properly designed interface at connection panel, and contact surfaces.
- Avoid crimp connections - all connections should be soldered. Clamp and solder outer contacts for best static and dynamic performance.
- DIN connectors are less susceptible to Intermodulation than N connectors.
- Avoid hermetic seals containing Kovar.

Lightning Surge Current Ratings. Surge current ratings on coax lightning protectors are like horsepower ratings for cars. Is more better? Some manufacturers point to a 50kA rating and say the protector will take 50+ strikes at 50 kA before failure. Although this is interesting, you might also ask how much energy (with a 50 kA strike) does the protector let through to your equipment? The standard test for any coax protector is a 3kA 8/20 microsecond waveform pulse (other standard pulses are being introduced such as a 10/350 or 10/1000), with the output connector terminated in to a 50 Ohm resistive load. The let through energy is calculated from the integrated peak voltage and pulse width.

Since the purpose of any coax protector is to equalize the center conductor potential with the shield potential minimizing current flow through the equipment input, how much lightning current will actually be on the center conductor of your coax line? To answer this often-asked question, we need to determine two things:

- How much current is available?

- Into how many paths will the current divide as it travels toward earth ground?

The total current available from a direct strike is a given amount. Typically, the current will be below 65kA, a 50% occurrence strike will have 18kA, and only 10% will have more than 65kA. We will use the 65kA figure for this discussion.

For a tower with one antenna and coax line, the amount of current delivered to the master ground bar (MGB) or bulkhead is a function of where the line leaves the tower and the length of the run to the MGB. The higher the grounding kit is on the tower and the closer the MGB and cable entrance is to the tower, the more current will travel toward the equipment. It is all a matter of inductance. If more than one coax line is on the tower, the inductance path between the tower and the equipment will be less (inductances in parallel divide) and therefore, the strike current to the equipment will increase. Even though the total strike current to all the equipment is increased, the amount on each coax line will be less (divided).

In general:

- The more coax lines there are, the more the current is divided and the less there will be on any given line.
- The lower the coax is grounded to the tower, the less shield current there will be on each coax line.
- The lower the inductance path to ground from the MGB or bulkhead, the less shield current will enter the building.
- The farther the tower is spaced from the MGB/building entrance, the more inductance the coax line(s) will have, and the less current will be on the line(s). We do not recommend adding loops to increase inductance. They can couple more energy like a transformer (depending on orientation to the tower) instead of reducing it.

The total strike current will first be divided between tower (lowest inductance) and *all* coax cables. Current on each coax will be divided between the shield and the center conductor. The shield has a much larger surface area, therefore less inductance, so the higher frequency components of the strike will easily travel on it. This means the shield will have a higher peak current with a shorter duration while the smaller and more inductive center conductor will have less current but longer duration.

Typically, the center conductor will have less than half the total peak current. This means that when calculated, the typical center conductor surge on a coax cable is not 40kA, not 20kA, and not even 10kA. For only one coax cable and a 65kA strike (10% occurrence hit), a worst-case center conductor peak current value would be less than 7.5kA. For a cell site with nine (9) same-size coax cables, the center conductor peak current would be less than 850A each! The amount of strike current on the center conductor will have a slower rise time and lower peak current. This is important to know since 1/4 wave stubs or other dc coupled protectors, with a dc path on the center pin, will share this strike current with the equipment input.

A throughput energy rating, in Joules with a standard waveshape, is a much better way of evaluating the performance of a lightning arrester than knowing how many tens of thousands of amps is required to blow it up!

HIGH FREQUENCY RINGING

Antenna and 1/4 Wave Stub. If your antenna is hit or if a strike is close to the tower, the voltage rise times at the strike attachment point can be on the order of 20 to 50ns. This can cause antenna “ringing” since the antenna is a tuned circuit. Once this happens, the ringing will propagate down the coax line on top of the low-frequency energy going toward the protector.

A 1/4 wave stub will not reduce this on-frequency ringing and could increase the voltage since it too is a narrow band tuned circuit. In order to see this ringing, one needs a scope with a bandwidth large enough to cover the operating frequency. Many 1/4 wave stub manufacturers use 100 megasample/second scopes while looking at a 900MHz device and don't show the whole picture. Observations made, using a 4 gigasample/second scope, with a 1.1GHz bandwidth, show the ringing effects of cellular antennas when they are hit and have produced the same ringing effects in 1/4 wave stubs.

The PolyPhaser filter series protectors are a low Q wide bandpass tuned circuit and not as likely to ring as filters with a narrow bandpass high Q tuned circuit.

Secondary Effects. Since the shield also has a dc path to your equipment, the farther away the coaxial protector is from the equipment, the more likely it is to re-introduce the differential on the coax line. The coupling of the shield and center pin is what caused the differential initially. If the distance from the protector (on your single point ground) and the input on the equipment rack exceeds approximately 20 feet, another center pin protector should be mounted to the single point ground connection at the equipment rack.

ac & dc Power Protection for Communication Sites

The incidence of damage to equipment in general is higher from power line surges than by any other I/O port. This is not to say more energy comes through the power line, just that the damage is more visible there. Since

the coax connection to the tower is the source of the largest surge current in the building, power line port damage is usually due to improper grounding techniques and lack of surge protection devices. There are two probable ways power line caused equipment damage occurs.

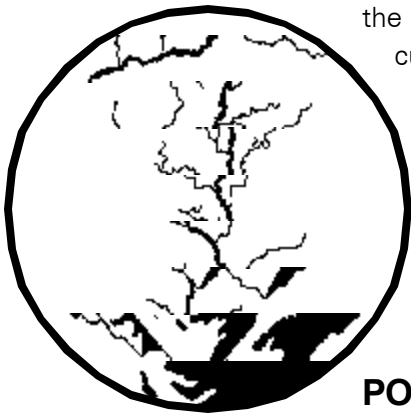

POWER LINE STRIKES

Surge current may be imposed on a power line by a lightning strike near the equipment or on an overhead utility line. Current may directly enter buried lines when lightning strikes a street light or may be conducted to a buried power line if lightning strikes near the line. Whichever way the surge current enters, it causes a bi-directional flow of surge current on the power line. Current flows both toward the equipment building and away from it, toward the nearest distribution transformer.

When the surge current flowing toward the equipment building reaches a distribution transformer, part of the energy is diverted to ground. Energy not diverted to ground is coupled through the transformer by arcing (non-catastrophic) or capacitive coupling. Surge current continues toward the equipment building on both the “neutral” and “hot” conductors of the power line.

At the building’s main power line entrance panel the neutral is tied to ground, reducing neutral conductor energy. Most of the energy from the lightning strike should remain on the “hot conductors”.

Since lightning is short in duration (20–350 microseconds) compared to 50/60 Hz fundamental ac frequency, the surge current may either take the form of a mostly positive ringing waveform, a mostly negative ringing waveform, or a combination of the two. It isn’t possible to state which is more likely at any given instance because the impedances along the path would have to be defined. These impedances include the surge impedance, the load impedance and the line impedance.

- *Surge source impedance* differs on directly struck power lines and with nearby strikes. The impedance changes as the surge current is conducted by arcing or capacitive coupling at one or more transformers between the strike and the building. The surge impedance also depends upon the impedance of each ground connection along the path, including the transformers and the point at which the power line enters the equipment building.
- *Load impedance* depends upon the amount of load inductance (power factor) placed across the line by devices such as air conditioners, heaters and lights.
- *Line impedance* is governed by the length and number of lines, and the line resistance and transformer impedance.

Impedance values for each of these elements are independent variables representing an infinite number of possibilities.

Because the surge, load, and line impedances cannot be easily defined, the lightning-caused voltage waveshapes are difficult to predict. Nevertheless, some standards have been developed to provide guidelines for possible values of surge voltages and currents induced into the powerlines by the lightning discharge.

Even though the peak values of lightning-induced voltages and currents are important, the waveshape they take (i.e., rise time and duration) are critical to determine the total amount of energy in the lightning discharge.

One Standard that has been formulated is designated ANSI C62.41 - 1991. This standard defines voltages/current waveforms and location categories for given surge exposures (Figure 1).

A 6kV 100kHz 200A & 500A ringing waveform:

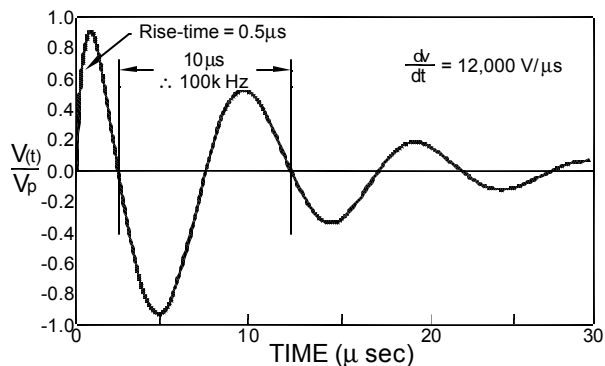

100 kHz Ring Wave
(Figure 2)

Figure 1
IEEE C62.41-1991 LOCATION CATEGORIES

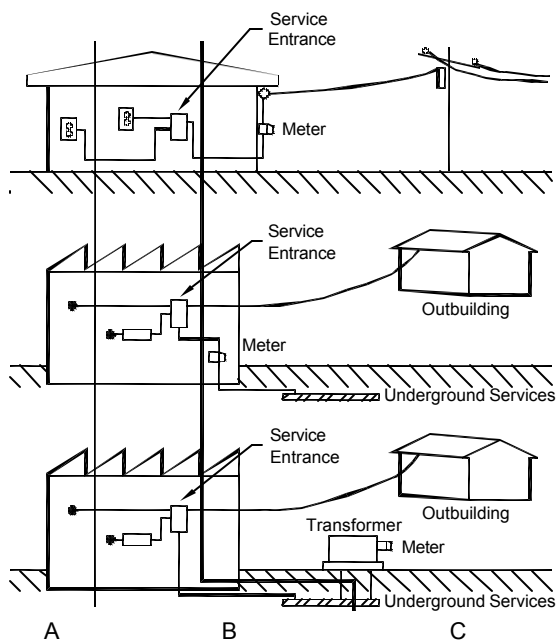

A - Outlets and long branch circuits;

- All outlets > 10m from B
- All outlets > 20m from C

B - Feeders and short branch circuits;

- Distribution panel devices.
- Bus and feeders industrial plants.
- Heavy appliance outlets with "short" connection to service entrance.
- Lighting systems in large buildings.

C - Outside and service entrance;

- Service drop from pole to building.
- Run between meter and panel.
- Overhead line to Outbuilding.
- Underground line to well pump.

Demarcation between Location Categories B and C is arbitrarily taken to be at the meter or at the mains disconnect. (ANSI/NFPA 70-1990(2), Article 230-70) for low-voltage service, or at the secondary of the service transformer if the service is provided to the user at a higher voltage.

- **Category A** is for "long branch" circuits such as long run secondary ac wall outlets. Its surge wave is a 6kV open circuit voltage, and 200A short circuit ringing waveform (damped cosine) with 0.5μs rise time and a frequency of 100kHz (Figure 2).

- **Category B** is for major feeders, short branch circuits, and receptacles located near an indoor main distribution panel. There are two waveshapes designated to a category B location:

(1) 100 kHz Ringing Wave - A 6kV open circuit voltage and 500 Amp short circuit ringing wave with a 0.5μs risetime and a frequency of 100kHz (Figure 2).

(2) Combination Wave – A wave combining a 6kV, 1.2/50μs open circuit voltage, and a 3kA, 8/20μs short circuit current (Figure 3 & 4).

- **Category C** is for outdoor overhead lines and service entrances. The waveform is the same as a category B combination wave, however the currents and voltages are higher (6kV at 3kA, 10kV at 5kA, and 20kV at 10kA). The current values are derived from the surge generator impedance, and the surged load impedance.

Combination Wave, Open-Circuit Voltage
(Figure 3)

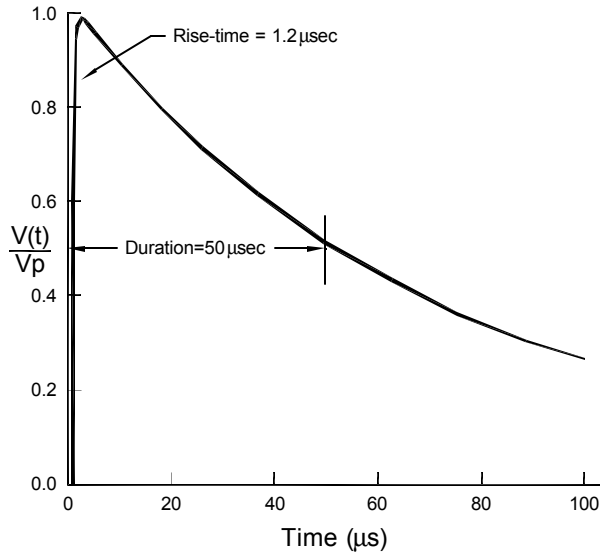

Combination Wave, Short-Circuit Current
(Figure 4)

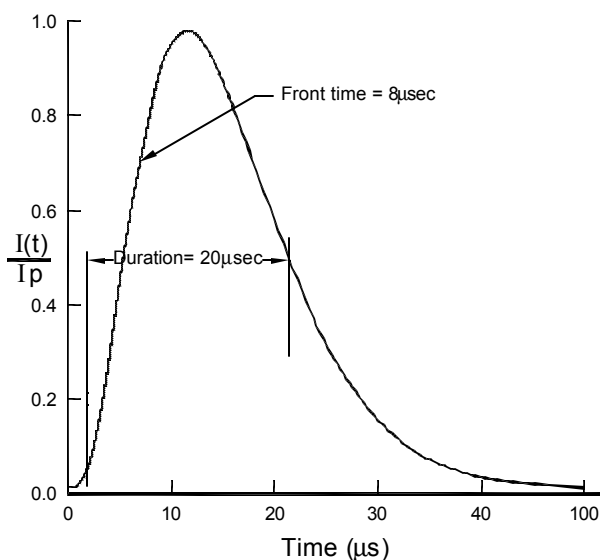

[GRAPHS FROM IEEE - ANSI C62.41 - 1991]

TOWER STRIKES

Surge current may also arrive to stress equipment within the building with a strike to the communication tower. In an ideal installation, the tower, bulkhead, equipment and utility grounds are all tied together with a single point ground. Just as it is impossible to define the power line surge waveforms accurately because many independent variables are involved, it is also difficult to predict exactly how much stress will be delivered to the power line circuits when lightning strikes the tower.

The *tower lighting* circuit is a surge producer often overlooked. Protectors are available to prevent this incoming surge energy from transferring to the building's power lines.

Approximations can be used to help predict the amount of stress expected for a single point ground system. If radial wires are installed with Ufer grounds at the tower base and connected to the guy anchors, surge current at the tower base is divided by the number of radials. A short radial (only one) should connect the tower base to the below grade perimeter ground. The perimeter ground encircling the equipment building should connect to the bulkhead and not to any radials. The utility ground should connect to the perimeter ground.

With this interconnection scheme, as indicated in previous chapters, it should be faster for the surge to propagate via the perimeter than it is to traverse through the building. If this isn't the case, major power supply stress may occur.

Surge current coming from lightning that strikes a power line some distance from the building may be divided several times as it flows through transformers and other devices, but it is important to design protection for the "worst case." Where lightning strikes the low voltage secondary conductors connected to the meter and main breaker, the current is divided. Current flows toward the building and also back towards the distribution transformer. Surge current flowing towards the building may be in the order of 10kA or more. A power mains protector is needed to protect the distribution panel and connected equipment. Protectors must be able to withstand line current surges greater than those specified by the IEEE/ANSI standards.

The one way to *theoretically* limit stress on the equipment's power supplies is to provide additional inductance (isolation) for the power line path inside the equipment building. Higher inside inductance forces more surge current towards the outside perimeter ground path. Additional inductance can be made by placing the lines in EMT conduit, using long power cords to the equipment or winding coils in the power cord. (Remember, like coax coils,

there is a limit to the voltage isolation achievable before breakdown.)

One possibility for damage remains in spite of this precaution. The phase conductor for the 60Hz power may be at a voltage peak when the surge occurs, causing a breakdown. For critical applications, an additional power line protector is recommended at the equipment rack.

An outlet strip type protector, that plugs into a wall socket (the type often advertised in connection with computer/consumer equipment), may not protect the equipment because it is "grounded" at the plug socket not the single point ground. The plug socket safety ground wire is "in the middle" of two inductances (the power cord inductance from the equipment, and the safety wire inductance running back to the breaker box and power company ground rod) and is effectively removed from earth ground by the series inductance of the ground wire. The actual current an "outlet strip" type protector will conduct to earth ground during a strike is limited by the series inductance of the safety wire path and will rarely conduct current flow close to advertised ratings. There will be a peak voltage differential between the safety ground and the bulkhead single point ground during a lightning strike. The differential could be several kilovolts and cause damage to equipment in this current path.

For applications where there are no other ground paths and the ac safety ground is the only ground available, this ground must be used. Be aware of possible outbound current flow to lower potentials through other safety ground "protected" equipment I/Os.

PROTECTIVE COMPONENTS

There are many books now on the market which address the design of components utilized in surge protectors. Most protectors use one or more of the following components:

- Air gaps
- Gas tubes
- Metal Oxide Varistors (MOV)

- Silicon Avalanche Diodes (SAD)
- Four-layer semiconductors
- SCR's

Air gaps handle high currents, but are slow to act and require regular inspection. Altitude, temperature, humidity, pollution, corrosion, shape and spacing all effect air gap performance.

Gas tubes are better than air gaps, but both share the problem of "follow-on" current. When surge current occurs during the instant that 60Hz ac is at a zero potential, follow-on current is not a problem. If the surge arrives at any other time, triggering an arc, the arc could be sustained by the power from the 60Hz source. The arc extinguishes when the waveform voltage falls below the arcing voltage. This voltage can be even lower if radioactive isotopes are used inside the gas tube. The US military now requires all gas tubes be non-radioactive.

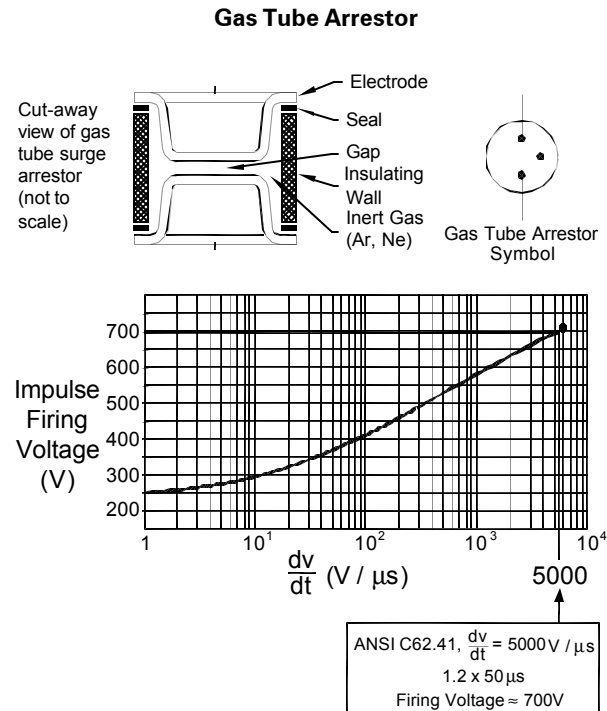

Gas Tube Operation Waveform

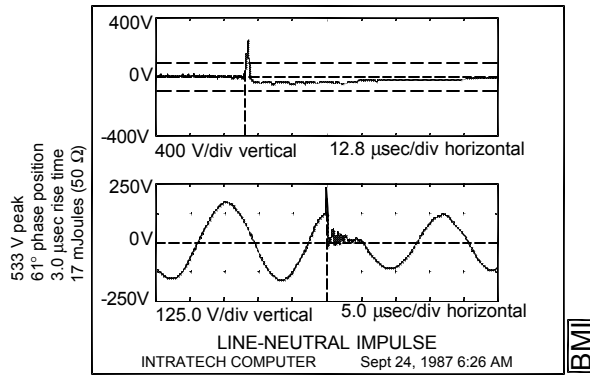

A power loss of up to 1/2 cycle (8.3ms) can result from a gas tube turn on that may cause problems with sensitive equipment. The air gap and gas tube are much like Silicon-Controlled Rectifiers (SCR); once in a conducting mode, the voltage to it must be almost completely removed to open the circuit again.

There is another dilemma with air gaps and gas tubes. As they “crowbar,” the dv/dt created is high in harmonic energy and can be coupled capacitively through power supply transformers causing problems in sensitive circuitry.

The **metal oxide varistor (MOV)** does not “crowbar,” it “clips” or “clamps,” starting at a given turn-on voltage. MOVs handle moderate amounts of surge current and have a finite lifetime. The devices are made from zinc oxide granules. As the voltage across it rises above turn-on, electrons tunnel through and conduction occurs. The granules heat and melt together. Melted granules cannot reunite to form zinc oxide. In the end, the MOV is mostly zinc and short circuits. With heavy usage, the MOV life is shortened.

Metal Oxide Varistor (MOV)

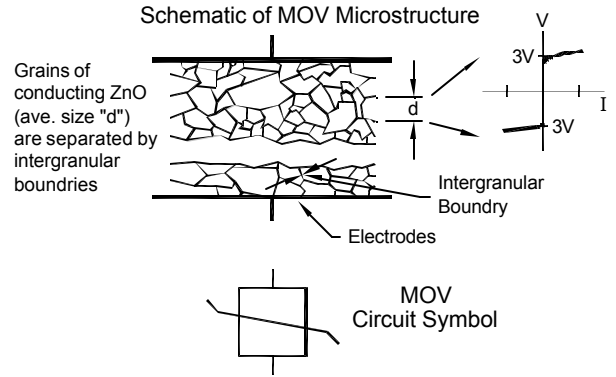

Surge currents conducted by the MOV create a voltage drop through the MOV. As current increases, the voltage drop rises. The action is non-linear and is often referred to as the “clamping ratio.” In an ideal situation, the voltage would remain the same regardless of current.

High pulse current diodes (also known as **silicone avalanche diodes, SADs**) come in a variety of configurations. They have a more ideal clamping ratio than MOVs with a faster response time to the surge wavefront. Their lifetime is unlimited if surge currents remain within specified current handling ranges. Unfortunately, SADs do not handle much surge current in a single component package. Special consideration must be given to SAD surge protection device design to insure necessary power handling capability. SADs and MOVs still act much faster than air gaps and even most gas tubes.

Silicon Avalanche Diode (SAD)

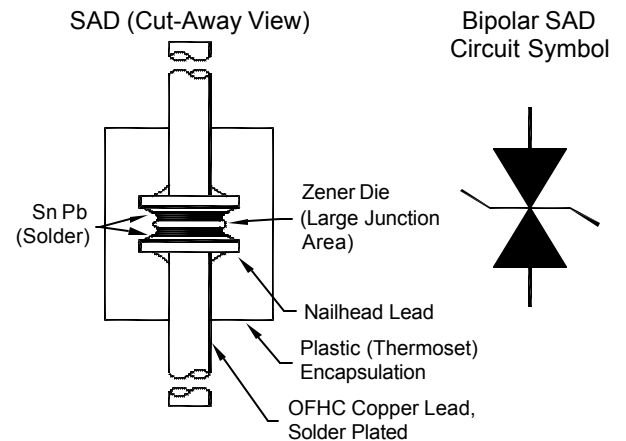

The SAD's and MOV's speed is due partially to their high capacitance. Surge current charges the capacitance, making the effective response time of a leadless MOV less than a nanosecond. A large pulse-handling SAD may have high capacitance. A leadless chip SAD reacts in picoseconds.

SADs and MOVs are rarely used without leads, even though leads add inductance. Leads must be connected to these devices when they are used in a protector. Protectors using either SAD or MOV components are often advertised as having sub-nanosecond response times. To accomplish this, they must use lowpass filtering to offset the inductive lag, insuring a quick response. Power line protectors advertised as having sub-nanosecond response time have misleading specifications if they do not have lowpass filtering or leadless design and installation. Filtering is important to prevent small spikes, surges and noise. Although the voltage excursion of such spikes, surges and noise may not be hazardous, it may cause equipment problems.

Another device listed is a **four-layer semiconductor**. It is a "follower" or "negative resistance" device, much like the SCR. It handles more current than a SAD of the same size because of its crowbar action and unlike the SCR, it has a "turn-off" voltage.

Four-layer semiconductor protection devices are not limited to power line applications. They may also be used on telephone or control lines, alone or in complex combinations (hybrids).

The last device on the list which could be applied in a protection circuit is the **SCR (Silicon Controlled Rectifier)**. This device comes in a variety of sizes and could be very fast when teamed up with an SAD or MOV. The SAD/MOV provides the speed and the SCR protects the SAD/MOV from long duration surges. In power main applications, the SCR's dv/dt problems could be buffered by the capacitance of the SAD/MOV and any filtering that is present.

AC MAIN POWER PROTECTOR TYPES

Parallel or Shunt Type Protector. The shunt type ac protector is the most common protector circuit in use today. It can be a simple MOV from each lead to the safety ground, matched MOVs or SADs in a differential and/or common mode, or a hybrid circuit of cascading components for fast turn-on and high surge current capability. The shunt type protector is not load dependent and must be located close to the entrance panel to reduce propagation delays. A 10kA rated protector in a *typical installation* will rarely conduct anything close to its current rating except during a direct strike to the secondary drop at the entrance panel. The amount of current the protector will conduct to ground depends on the equipment load impedance, the inductance of the ground conductor on its way to earth ground, and the fall of potential resistance/impedance of the earth ground system.

Series In-Line Type Protector. An In-Line ac power protector consists of a pair of protective devices or hybrid circuits per phase, connected line to ground, one on each end of a load bearing air wound (air will not saturate) series inductor. There should be a circuit breaker or fuse in series with each non-linear device or hybrid circuit that opens in the event of a failure of the suppressor stage (they usually fail shorted), allowing power to continue to flow to the load. If a protective device fails, the associated circuit breaker opens and could activate an alarm circuit. There could be fixed capacitors in parallel with the intrinsic capacitance of the protective device(s) forming, with the series inductor, a Pi Network low pass filter. The additional capacitance absorbs some of the fast rise time energy as the device is turning on, and the low pass filtering provides EMI/RFI filtering to the protected lines. Turn-on time would not be an issue due to the "filtering action" of the circuit.

If there were two MOVs (for example) in each phase, separated by a series air wound inductor, the second MOV would be there to make a (nominal) current flow in the inductor creating a

voltage drop. This drop limits the current to the equipment side MOV and allows the surge side MOV to take the brunt of the energy. The voltage across the surge side MOV will rise as increasing surge current goes through it (clamping ratio). The voltage difference between the surge MOV and the equipment MOV is the voltage drop through the coil ($E = Ldi/dt$). Since the equipment MOV is not seeing as much voltage, its current will be smaller. This is desirable since the voltage across the equipment MOV will be the same voltage applied to the protected equipment input. The life of the equipment MOV will be longer than the surge MOV. The same surge current limitations caused by inductive ground connections and/or ground system resistance/impedance apply.

A shunt type or series type protector can conduct surge energy to their capacity only if attached to the site single point ground with a low inductance connection to a low resistance/impedance, fast transient response ground system.

Applying a single point ground protector retrofit to a site with coax entry on one wall and ac power on the opposite wall?

The ground connected to the ac power protector should be referenced to the single point ground. Assuming a tower strike, the inductive peak voltage drop across the current carrying ground leads (preferably copper strap) from the ground bar or bulkhead to earth would elevate the potential at the ground bar compared to the (lower) earth ground connection. The ground bar is directly connected to the equipment cabinet(s) through the coax cable shield(s).

All equipment ground connections should rise and fall in potential at the same time with no other paths (through equipment?) to a lower ground potential connecting point. If there are no other paths, and the potentials rise and fall together, there will be no current flow through the equipment.

If the protector and ground connection is on the opposite wall connected to a ground rod or ring, there could be damage from current flow from the elevated potential on the coax cable shields,

through the equipment, back to the ac power ground on the opposite wall (that has not yet been elevated in potential) due to ground potential propagation delay around the ground ring. There could be an additional danger from the energy coupled to parallel or nearby conductors. The peak potentials could be additive and cause serious damage.

A protector mounted on the opposite wall next to the main ac entrance panel, and connected to the power company ground rod, would only protect from incoming energy on the secondary ac power conductors. Energy from a tower strike would elevate the equipment cabinet potential via the coax cable shields and current could flow from elevated rack/chassis ground returns up through power supply circuitry on its way to the outside world via the yet to be elevated ac secondary connection. The power supply could be destroyed.

If a protector ground was connected to the (elevated) single point ground bar and true single point connections were maintained:

- The equipment protector reference ground would rise and fall with the master ground bar potential.
- The ac power protector would protect the equipment power supplies from incoming energy on the ac power lines AND from direct or induced energy incoming from the coax cable(s) during a tower strike.

One practical way to do a retrofit could be:

- Remove any equipment rack or active electronic equipment circuit breakers from the existing distribution panel. Remove all wiring from the existing distribution panel to any equipment rack or active electronic equipment. Leave the existing shunt type ac protectors at their original location.
- Run a steel conduit, grounded at both ends, from the existing main distribution panel to a new sub-panel. Route new interconnection wiring through this conduit.

- Install a new sub panel next to the single point ground (MGB). Wire from the new sub panel, through a properly rated circuit breaker, directly to each rack or active electronic equipment.
- Connect a second shunt type ac protector to the hot leads and neutral in the new sub panel. *Strap the protector case ground to the single point ground.* For higher levels of protection and RF-EMI filtering, use an in line filtered ac protector. This device installs in series with the wiring from the existing distribution panel to the new sub panel.

If there is already ac power shunt type protection installed at the main ac input, *leave it there*. It will provide an extra measure of protection from an incoming strike on the secondary conductors.

AC LINE REGULATION

An ac line protector is not intended for power conditioning or over-voltage conditions. An ac line protector is specifically designed to protect equipment from short duration (nano/micro-seconds) high energy “spikes” caused by lightning events or other short term transient artifacts on the ac line. Extended surges and sags are handled with uninterruptable power supplies (UPS), and/or regulation transformers and/or brute filtering. Frequently, improved service grounding (earthing) can significantly improve “dirty” utility company power.

COMMUNICATIONS SITE GENERATORS

All inside or outside generators must be connected to the perimeter ground. Both the neutral and the metal housing are to be grounded. All fuel tanks must be grounded, even if they are buried or tar coated (insulated). The location of the ac mains protector may be changed depending on the location of the generator and transfer switch.

Some generators hunt/vary their frequency or output voltage causing equipment problems. Protectors placed on the output or load side of

the transfer switch will not remove long duration voltage peaks. They may be damaged or destroyed. Lightning protectors should be placed on the utility input side of the transfer switch.

BATTERY AND CHARGER PROTECTION

Some installations use batteries in combination with a charger to supply power to the equipment. The charger needs power line protection to survive a surge from a lightning strike.

Batteries that are in good condition provide substantial line-to-line capacitance, but they don't protect from common mode surges (lines to ground). If the batteries are located near the charger and the dc power lines to the equipment are long (inductive), a dc over-voltage protector may be needed at the equipment.

In non-screen room installations, long dc power lines will pick up the electromagnetic pulse of a nearby lightning strike. A capacitor bypass network can be used to shunt the pulse to ground. The network should have four parallel capacitors connected with very short leads. Values of 0.01 μ F, 0.1 μ F, 1 μ F, and 10 μ F are recommended. A high pulse current SAD may also be incorporated to clamp over voltages and reverse spikes from the equipment's dc power line. Be sure the turn-on voltage is high enough so the battery surface charge will not turn on the SAD. The SAD, like the MOV lightning protector, should not be used as a shunt type voltage regulator. EMP pickup can also be reduced by enclosing the dc lines in metal conduit. The conduit is grounded only at the equipment end.

Batteries should not use the earth ground bus in the equipment room as a means of providing a return circuit. Separate conductors for positive and negative connections should be run to each piece of equipment or equipment noise could be spread throughout the ground system.

Some manufacturers ground the negative (or positive) side of dc operated equipment to the chassis/rack. This reinforces the need for local dc over voltage protection since the chassis ground potential follows the rest of the ground system's potential during a lightning strike and could go up.

Stress could occur at the battery charger output because of the difference (inductive delay) in the positive and negative lead lengths and chassis ground. The problem can be solved by using and MOV/SAD devices at the charger output. The device's capacitance should be balanced (equal) to prevent hum pickup. They should be placed between each floating output and chassis ground.

The SAD/MOV device prevents an arc breakdown from occurring within the charger. Such a breakdown could damage components. Choose an SAD/MOV device rating high enough to allow the charger's maximum dc voltage to pass. Additional components could be installed at the equipment end to provide local protection.

Connections inside the equipment building should be free of paint and clean of all contaminants. Copper based joint compound is recommended. The connections should be tested when made as a preventive maintenance procedure.

At battery-operated sites, the ground connection may have dc current flowing through the joint under test and a negative resistance value may be displayed. Whether displayed or not, the DVM will need to measure the joint in both directions (reverse leads). The algebraic sum or the difference between the two readings, if both are the same polarity, will be the real ohmic value.

SOLAR PANELS

At installations using solar-power photoelectric cells, the lines connecting them to the regulator can act as an antenna capturing the radiated surge fields of a lightning strike. Spike voltage line-to-line may be low because of the solar cell's impedance, but the surge voltage from each line-to-ground may be quite high.

The high line-to-ground voltage could stress or cause premature failure of the series pass regulator. Any regulator failure means eventual outage for the equipment. SAD/MOV surge suppressor devices should be applied to limit transient voltages.

Never attach a lightning rod to a panel support, no matter how exposed a solar panel is to a direct lightning strike. The most effective way to protect solar panels is to use a lightning strike divertor placed a short distance away from the panel.

Telephone Network & Computer Interfaces at Communications Sites

An entrance protector is required for telephone or control lines for the same reason an entrance protector is needed for power lines. The local telephone

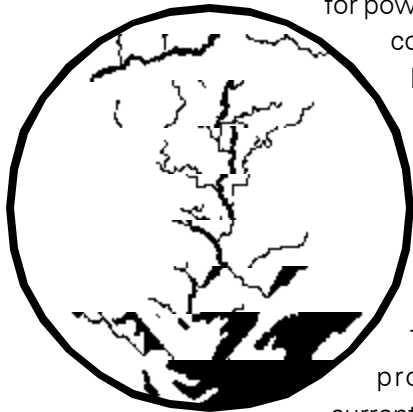

company usually supplies the building entrance station protector as part of their installation service. This is usually a single gas tube per wire type protector. Ground it to your perimeter ground system. The telco supplied protectors prevent surge currents from entering the building and radiating a magnetic field inside the equipment room.

If a better protector is desired, it should be used in addition to the telco-supplied protector and installed after the demarcation block. The telephone lines should be run to the bulkhead panel in EMT conduit to prevent surge magnetic field pickup. Install the additional secondary protector at the bulkhead panel for single point grounding.

The telephone lines running between the entrance protector and the single point ground secondary protector are inductive and will impede fast rise time current. If the distance is short, inductance can be increased by using metal conduit or shielded loops. The line may also be enclosed by a metal conduit grounded on the equipment end or looped several times inside a steel (ferrous faraday shield) NEMA enclosure.

FEWER LINES NEED BETTER PROTECTION

Dedicated lines for dc remotes, tone remotes, data lines and audio lines should be treated in a manner similar to the telephone line. Since the total surge energy is a given amount, the more line pairs that enter the building, the less surge current per pair. A single pair, terminating at the equipment, needs a better protector (multi-stage) than each pair of a 25-pair line terminating at the same equipment.

For multi-pair installation, extensive use of balanced MOV/SADs provides both protection and capacitive filtering. The MOV/SADs should be placed line-to-line and line-to-ground. To prevent pair imbalance that could induce a differential voltage, both of the line-to-ground MOV/SADs should be selected so their turn on voltage matches to within 5%. The turn on of the line-to-line MOV/SAD is not critical.

PROTECTOR PLACEMENT

Protectors should be placed on the bulkhead panel in buildings using the single point grounding technique. This allows each I/O protector (coax, power and telephone lines) to have a low inductance interconnection to the perimeter ground, as well as to each other. In an installation without a bulkhead, the I/O protectors should be placed on a single point grounding plate connected to the perimeter ground.

THREE-ELEMENT GAS TUBE

The telephone company will usually supply a gas tube protector at the building entrance. The gas tube was originally designed to replace the older carbon buttons that became noisy with use and required maintenance. Actually, the carbon buttons weren't intended to provide lightning protection, but rather to protect personnel in the event a power line came in contact with a telephone line.

Both the carbon button and the gas tube are inadequate for protecting equipment. On balanced telephone lines both the voltage above ground (common mode) and the voltage between lines (differential mode) are important. When individual crowbar devices are used, one for each side of a single pair (line), usually one device fires before the other, creating a large differential voltage that can damage equipment.

One solution is to use a *three-element gas tube*. This device has a common gas chamber with two gaps, one on either side of the grounded electrode. When one side of the line reaches the ionization potential of the gas, both sides fire simultaneously to ground. Once again, because of the rapid change (dv/dt) caused by the device firing, it is important to use some lowpass filtering.

Telephone lines, data, or control lines are similar to power lines since they provide two directions for the surge energy to flow. Since telephone, data, and control lines use wires smaller than ac power wiring, they have more impedance (inductance and resistance). With higher impedance the physical damage caused by the surge current decreases.

VOICE/DATA I/O

Fiber optics with non-metallic armor or strength members are the way to go, if it is affordable. This will eliminate one I/O hazard.

If wire pairs are used, protectors are necessary. Gas tube type arrestors installed by the phone

company, will soon be outdated. The large dv/dt created with the crowbar action of the gas tube will cause on-line transient problems with digital equipment. Lowpass filtering is important to limit the harmonic energy created by the crowbar action of the gas tube on wire lines. Non-crowbarring protectors such as capacitively balanced MOV/SADs are recommended.

For L-carrier coax, a coax grounding kit should be used prior to entering the building. A coaxial protector should be used to protect the equipment from the center conductor's differential surge energy.

For T-carrier on pairs, (and LAN) special protectors with high bandwidths and low (logic level) turn-on levels should be used. Special units for telco (span line) repeaters (current loop) are available.

EQUIPMENT ROOM PRECAUTIONS

Always use anti-static floor material to prevent Electro-Static Discharge (ESD) buildup and to allow bleedoff of existing charge on personnel and moving carts. Anti-static flooring will prevent ESD buildup, but is of too high impedance to bleedoff previously acquired charge. Ground the metal posts that support computer room raised floors. EMP gasket material should bond the cast aluminum tile squares to the structural posts. This technique will not only aid in ESD, but will also form a ground plane which will be beneficial for EMP attenuation, if the room is not a screen room enclosure. Other means such as ion generation may also be helpful.

Another problem is not maintaining a low inductance interconnect path between protectors (L & T-carrier, power and other incoming pairs) and between protectors and system ground.

The most common problem found at sites and computer rooms is the practice of running lines that can carry surge current together with other lines that should be quiet. For example, ground conductors from protectors being run together or crossing with other ground lines, battery return

lines, and data lines. The coupling of the surge to the other clean lines can cause major equipment glitches or even down time. EMT conduit grounded on one end is the best way to provide faraday shielding.

COAXIAL CABLE DATA LINES

Communication lines that travel from one floor to another, or from building to building, can pose a surge threat to equipment I/Os, as well as hum or ground-loop problems.

Coaxial cable has more problems with ground-loop currents than a balanced twisted pair. The coax shield is normally grounded to the signal ground at each end, which in turn, is grounded to the local power line neutral and earth ground. Two different

earth ground locations can cause ground loop currents to flow on the shield if there are ground potential differences. Grounding the coax shield only at one end sometimes solves the ground loop, but can create other problems.

Another solution uses a PolyPhaser protector with shield continuity mounted on a ground isolator. The ground isolator can withstand up to 90V shield to ground potential without turning on. The incoming coax cable shield is not connected to the remote equipment local earth ground unless a 90V potential is exceeded. Protection is provided while still ensuring the quality of the data.

For protection at the terminal end, a standard coax protector with no isolator may be used (see ground loop discussion on page 73, "Security Cameras").

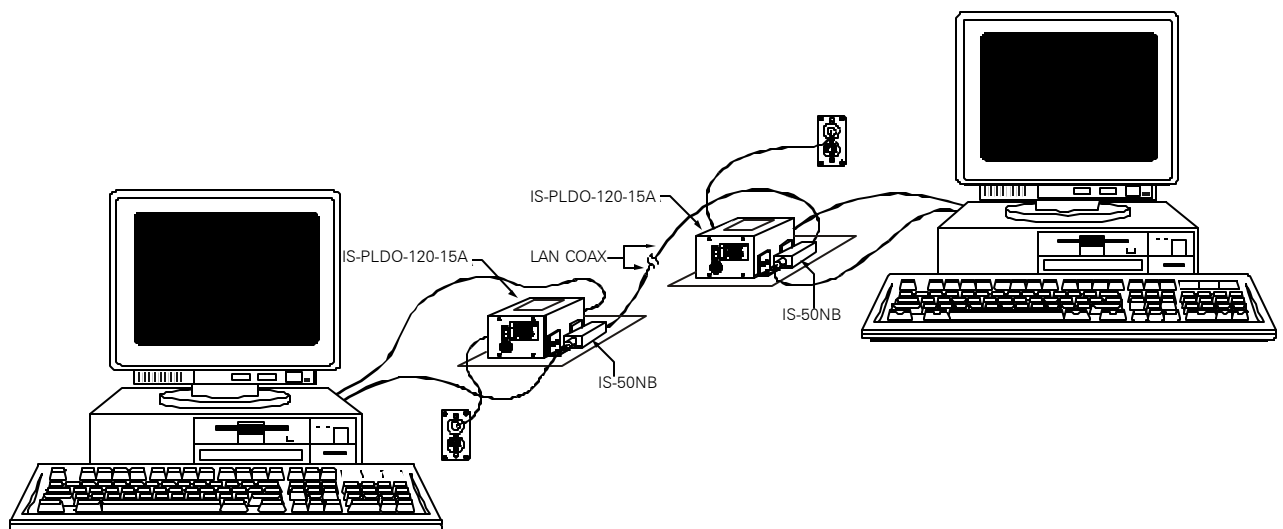

Protecting Equipment from NEMP Damage

The sudden release of gamma rays (high energy rays) in a nuclear explosion will cause almost instant ionization (the removal of electrons from atoms) of the atmospheric gases that surround the detonation. Free electrons

are driven outward. Gamma rays can travel great distances ionizing the atmosphere.

This forced movement of electrons, which will again recombine with atmosphere atoms (Compton Recoil Effect), creates a pulsed electromagnetic field (EMP), or "Electromagnetic Pulse." This is also referred to as "Nuclear

Electromagnetic Pulse" (NEMP). About 99% of the NEMP is radiated in a broad spectrum between 10kHz. and 100MHz. Most of the energy is at frequencies below 10MHz. For comparison, lightning's power density spectrum is from dc to 1 MHz (for the -3dB point).

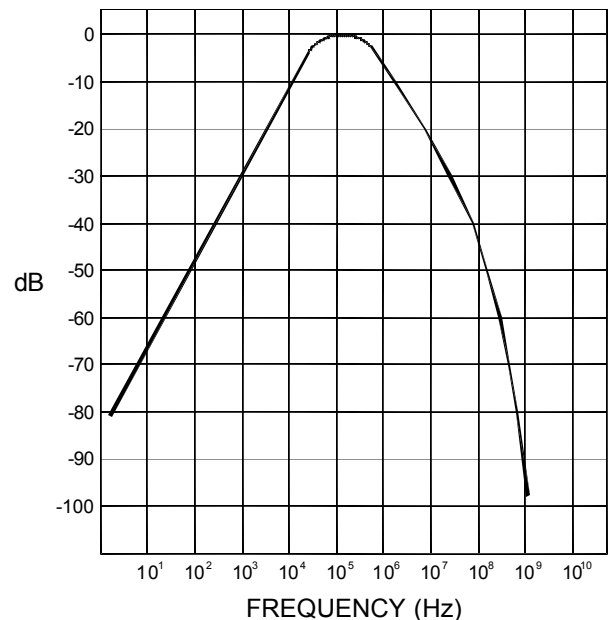
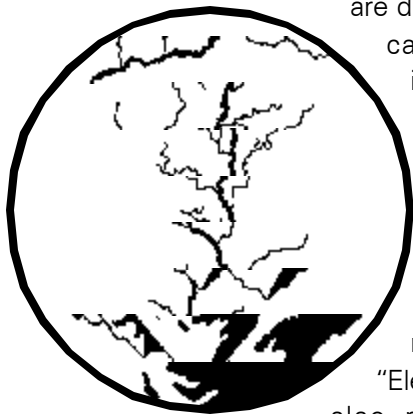

Normalized NEMP spectrum shows most RF energy from pulse falls at frequencies below the 10MHz amount. 99% of energy is within the spectrum from 10kHz to 100MHz

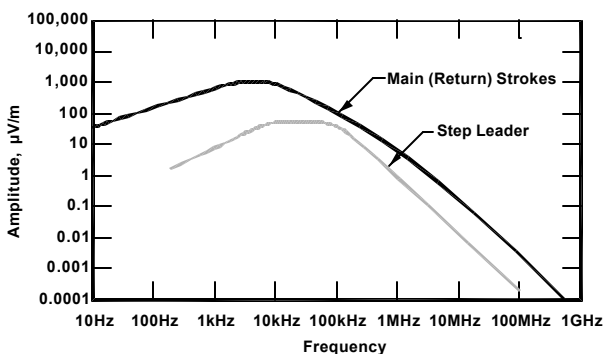

Amplitude spectra of the radiation component of lightning discharges.

The fast rise time of the radiated pulse (10 nanoseconds,) as well as its short duration (1.0 microsecond,) can cause any antenna to ring much like a direct lightning strike. The ringing amplitude would depend on the amount of captured energy. The antenna's capture area, its pattern relative to the blast, tuned frequency, and bandwidth, all affect the peak ringing voltage that will be present. This ringing voltage will attempt to propagate down the transmission line (open-balanced or coax-unbalanced) to the equipment.

Since the antenna impedance is not equal to the line's characteristic impedance over the entire NEMP spectrum, and the line may also collect

NEMP energy. If additional shielding precautions are not taken, the energy could take the form of a complex waveform on the transmission line. Large voltages may be created due to line and antenna resonances. These high voltages can cause damage to unprotected equipment or cause arcing in the line or at the antenna. Cable shield grounding kits help prevent the lower-frequency components from being present on coax cable and may change the high-voltage resonance locations.

Cavity filters could increase NEMP damage. The small bandwidth (high Q) of the cavity causes larger ringing voltages to be present at the equipment than the equipment would receive if the cavity filters were not in-line. Quarter-wave shorting stub type protectors, depending on their "Q", may also worsen the effects.

Coaxial lightning arrestors with a 50ns response time are too slow for the NEMP ringing pulse for systems above 20MHz.

NEMP PROTECTORS

Only NEMP coaxial units with a 1.0 to 7.0ns response should be considered for protection. NEMP protectors *with dc continuity* must have at least 10 feet of coax between the protector and the equipment. Since coax has a velocity of propagation factor, the NEMP rise time is delayed in reaching the equipment. This gives the protector time to operate. If this type of NEMP protector is placed directly on the equipment, a receiver (for example) would be required to develop an L di/dt voltage drop across its internal static drain inductor large enough to allow the protector to operate. The inductor value (which depends on the receiver frequency), the maximum current/voltage that the inductor can withstand, and the threshold of operation for the protector, will all determine the condition of the receiver after the NEMP event.

NEMP protectors that *do not* have dc continuity (dc blocked) will work on all equipment and do not need special precautions. They will work for lightning as well! Lightning radiates much like NEMP, but is more localized.

Type of Conductor	Rise Time (Sec)	Peak Voltage (Volts)	Peak Current (Amps)
Long Unshielded Wires (power lines, large antennas)	10 ⁻⁸ - 10 ⁻⁷	10 ⁵ - 5 x 10 ⁶	10 ³ - 10 ⁴
Unshielded Telephone and AC Power Line at Wall Plug	10 ⁻⁸ - 10 ⁻⁶ 10 ⁻⁷ - 10 ⁻⁵	100 - 10 ⁴ 10 ³ - 5 x 10 ⁴	1 - 100 10 - 100
HF Antennas	10 ⁻⁸ - 10 ⁻⁷	10 ⁴ - 10 ⁶	500 - 10 ⁴
VHF Antennas	10 ⁻⁹ - 10 ⁻⁸	10 ³ - 10 ⁵	100 - 10 ³
UHF Antennas	10 ⁻⁹ - 10 ⁻⁸	100 - 10 ⁴	10 - 100
Shielded Cable	10 ⁻⁶ - 10 ⁻⁴	1 - 100	0.1 - 50

Typical EMP energy collectors and responses.

POWER LINES

Utility lines act as a bandpass filter to the NEMP pulse. Transformers attenuate energy below 1MHz and capacitively couple energy to about 10MHz. Secondary ac power line protection with response times of 50ns and less should be used at or on the equipment.

TELEPHONE/CONTROL LINES

Twisted pair lines can couple some NEMP energy, but not as much as the coax or power lines. The higher inductance, smaller wire used for these applications limits the total energy delivered to the equipment.

NEMP does not have the same amount of energy as a direct lightning strike, it doesn't last as long and usually doesn't generate the high peak currents (20kA) of lightning. Rise times are a function of the coupling impedance to the unit under test, as well as the unit's dynamic surge impedance.

All of the grounding techniques for lightning protection previously discussed apply to NEMP. Most importantly, *long equipment interconnection lines can couple NEMP energy*. Long lines will also have larger voltage drops across them because of the faster rise times involved (L di/dt). Extensive individual shielding of the inter-equipment wiring is necessary. The most cost-effective way to provide shielding for a room full of equipment is a screen room enclosure. The next most important part is to provide a ground system that will actually dissipate the fast NEMP pulse.

Security Cameras, CATV, GPS & Satellite Protection

Outdoor Closed Circuit Television (CCTV) Security Cameras can be a prime target for lightning. They are usually mounted on a building or other vantage point such as a metal or wood pole. A lightning strike can not only destroy the camera, but can damage your control console due to energy flowing back through the coax and camera power wiring.

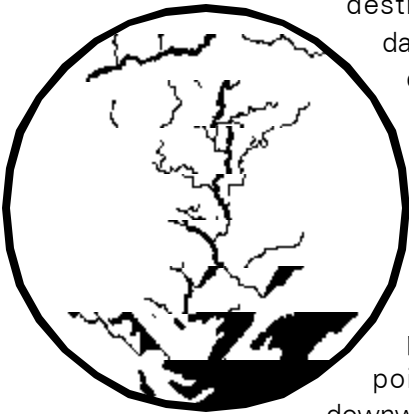

When lightning strikes a tower or other large structure, there is a high peak voltage at the strike point flowing outward and downward through any path it can find to earth ground. A support pole develops a high $L \, di/dt$ peak voltage drop along its length to earth ground. A large steel reinforced structure can conduct the energy to earth ground through its steel reinforced concrete footers and electrical ground system. A camera mounted and grounded to a building with steel reinforced construction will usually have less inductance to ground than a camera mounted on a self-supported tower or pole. Less inductance to earth ground means less peak voltage at the camera.

When lightning strikes a wood or other insulating support, whatever voltage is necessary to continue the arc is developed at the strike point to overcome the resistance of the non-conducting structure. This usually has catastrophic results.

The same conditions exist for both examples. A high peak voltage occurs at the strike point with

reference to earth ground. The video and power wiring to the camera are insulated from the strike point by the electrical circuitry involved and the external covering around the wire. The energy will flow through the camera in an attempt to equalize the wiring with the instantaneous peak voltage occurring at the strike point.

To protect your equipment, you must provide a low inductance path to earth ground for lightning energy and install properly rated protectors for all interconnected wiring from the camera to the operating console. A properly rated protector at the camera allows the wiring to be equalized to the peak voltage at the strike point without allowing damaging voltages across the camera circuitry. An appropriate protector at the console blocks damaging voltages incoming from the camera wiring.

A camera mounted on a building should be grounded to the building's structural steel as near the camera as possible. Use 1-1/2 inch copper strap. If the camera is mounted on a metal pole, it should be grounded to the pole and a proper ground system installed at the base. When mounted on a wood or other insulating support, the camera should be grounded to a 1-1/2 inch copper strap running from the camera mount to a proper ground system installed at the base. An additional 1-1/2 inch copper strap would run from a lightning rod or diverter to the ground system at the base. Separate the two straps on opposite sides of the pole and connect together below grade. Side mounting the camera or providing a diverter above the camera provides some additional protection from a direct strike.

A proper ground system would be capable of dispersing large amounts of lightning energy (usually electrons) into earth ground quickly. The faster it disperses electrons, the less time there is for damaging surges to flow in the coax and power wiring back toward your operating console.

The ground system under a metal pole could be a combination of a steel reinforced concrete base (Ufer Ground), radials and ground rods. If possible, exothermically weld a #2/0 AWG stranded wire to the steel mesh before pouring concrete. Attach this wire to a "J" bolt on top of the pad after the pole is erected. Use another wire welded to the mesh to attach additional radials with ground rods. If the concrete base already exists, attach additional radials with ground rods to any "J" bolt.

Be sure to remove paint and corrosion. Use a double nut attachment with joint compound. Space additional ground rods at least two times their length from each other and from the "Ufer Ground." (See illustration.)

When grounding a wood or insulated support, tie together both 1-1/2 inch straps, below grade, to a radial strap and ground rod system. A good layout for a "rapid response" low resistance/inductance ground system would be four 8-foot ground rods, one at the base and three spaced 120 degrees and 16 feet out forming an equilateral triangle centered on the base of the support. Each ground rod would directly connect with below grade 1-1/2 inch straps to the rod under the pole. (See illustration.)

Protector type varies depending on camera power requirements and environment. Numerous configurations are possible.

For example: A camera powered by 120 Vac would require a PolyPhaser IS-PLDO-120-15A at the camera. If there is insufficient space in the weatherproof housing, an IS-PSP-120 MOV/Gas tube hardwired shunt protector at the camera power input can be substituted.

If the camera is powered by 24 Vac, a PolyPhaser IS-SPTV twisted pair protector could be placed at

the camera and an IS-PSP-120 protector wired across the primary of the 120Vac to 24Vac power transformer at the console end of the cable.

In both examples an IS-75BB (75 ohm BNC female connectors) would be inserted in the video coax at the camera and control console ends. The protectors should be in a weatherproof location unless a water-tight version is ordered.

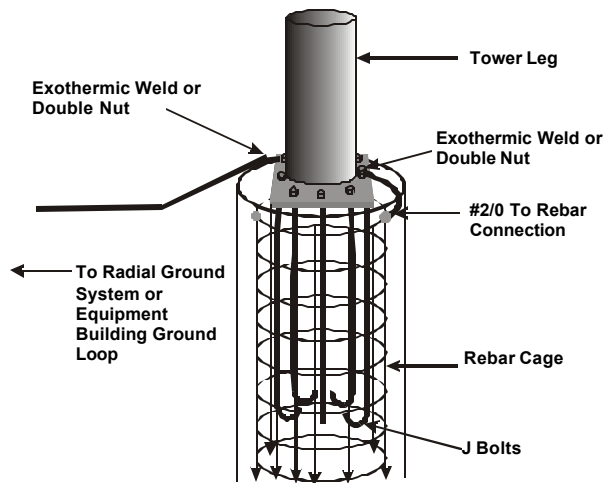

Ufer Ground

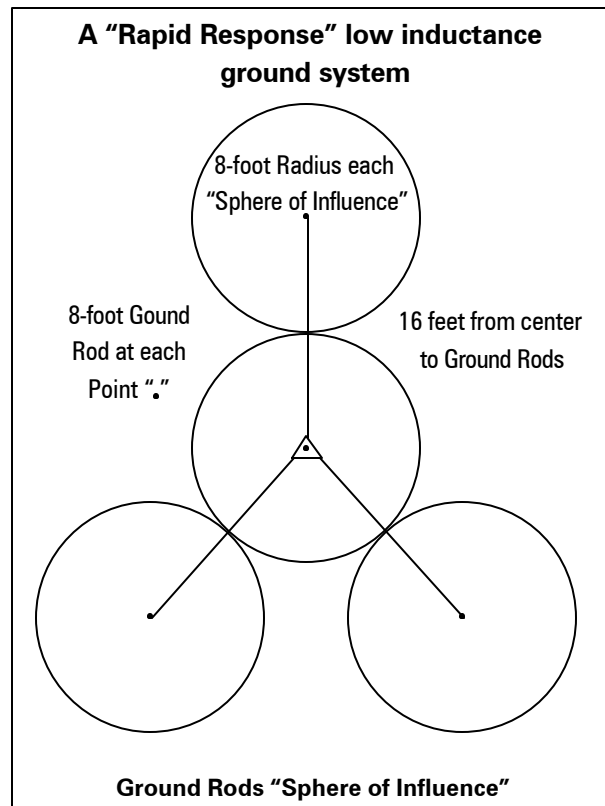

CATV CONSIDERATIONS

Almost everything discussed so far can be applied to a CATV head end. Trunk line amplifiers are very similar to the tower top amplifiers already described. They are powered via the coax line, usually with 60Vac (60Hz). The ac power is separated from the RF, optimally protected, then recombined on the equipment side.

The power line (neutral ground at the utility entrance) should be interconnected with the cable drop ground. The interconnection should be a wire placed in the ground (buried) for low inductance (if the soil is conductive) or should be a buried strap. Getting the ground connection in place and keeping it there can be simplified if the cable entrance point is located close to the power ground location.

GPS LIGHTNING PROTECTION AND ANTENNA PLACEMENT

The first consideration for a GPS antenna is a clear view of the sky, preferably 360 degrees. In the usual installation the GPS antenna is located low, close to the equipment building roof, or if an outdoor cabinet, mounted on the cabinet or very low on the adjacent monopole/tower. A direct lightning hit to the above mounted antenna is unlikely. Mounting on an equipment building roof or cabinet is the safest place since the potential rise on the outside of either of these structures would be more or less equal with the potential on the inside. The PolyPhaser protector is there to equalize the differential in potential that occurs between center conductor and shield of the coax cable on its way from the antenna to the receiver.

The zone of protection from various lightning rod types is an argued topic. Many claims are made for different configurations. If a Franklin rod is below 60 feet, we can assume a 45 degree "cone of protection". If above, we should apply the "rolling ball" theory (see pages 2-3).

If the GPS antenna is mounted on the monopole/tower, (since this is the structure we expect to be hit) there will be an inductive voltage drop occurring during the event that will be distributed down the structure to earth ground. This voltage drop is the result of the fast rise time lightning current pulse traversing the inductance of the structure. ($E = L di/dt$). If the GPS antenna is mounted on this structure it will be elevated to a potential higher than the equipment building or cabinet. There will be current flow on the shield and center conductor of the coax cable towards the receiver. A coax cable grounding kit or PolyPhaser integrated ground entry panel will direct the shield currents toward earth. A PolyPhaser coaxial protector will "turn on" and direct any current on the center conductor towards earth. Proper shield grounding and center conductor protection are essential to receiver survival.

Questions regarding GPS LNA protection in the antenna are valid but usually not considered in this application. The antenna element at GPS frequency is usually "grounded" and does not have the capture area to couple much energy to the preamp input, the problem is with the output. In roof or cabinet mounting there is not the potential that could occur with a monopole/tower mount. If the GPS antenna support structure is elevated in potential (due to its inductance), the GPS antenna/LNA will also be elevated to a potential determined by the voltage distribution across the structure, and the height of the GPS antenna mounting on the structure. Since the coax shield is usually common with the GPS antenna mounting bracket, current will flow down the shield. The voltage differential at the top of the coax between the shield and the not-yet-elevated center conductor will appear across the LNA output circuitry. The LNA output could be destroyed in the attempt to bring the center conductor up to shield potential. If another protector were installed at the output of the LNA, any voltage differential between center conductor and shield would "turn on" the protector. Current flow that would have gone through the LNA output now goes through the protector. The LNA would survive. The top protector could be combined with a voltage "pick-off" for power to the LNA. There are protectors in this configuration.

There have not been many failures (that we know about) with LNA's. The higher the GPS antenna is mounted on the support structure, the more probability of damage.

SATELLITE DISH CONSIDERATIONS

Most satellite dish antenna pier supports are encapsulated in concrete, which retains moisture for 15 to 30 days after a rain or snow melt. It absorbs moisture quickly and yet gives up moisture very slowly. Concrete's moisture retention, its mineral content (lime and others), and its inherent pH base of more than +7 means it has a ready supply of ions to conduct current. Concrete's large volume and great area of contact with the surrounding soil allows good charge transfer to the ground.

If a 4-inch pipe is placed four to five feet down in an 18-inch diameter (augered) hole and the hole is filled with concrete, it will provide a good start for a satellite dish ground system. This type "ground" is referred to as a "Ufer," so named after Herbert G. Ufer. *(For more information on Ufer grounds, see Chapter 3.)*

In areas of good soil conductivity (100 ohm-meters or better), the "Ufer" may be adequate for the antenna ground. Interconnect a below grade bare copper wire from the antenna pipe to the electrical (power) ground stake or rod. The copper wire should be 10 gauge or larger, at least 8" or deeper in the ground, and should be exothermically welded to the pipe. The weld will ensure a good mechanical and electrical connection. Exothermic welding is a simple process which joins even dissimilar metals without a problem and requires a fixture (mold), or "one shot" connection kit.

If the water table at the installation site is over 10 feet deep, the Ufer ground should be augmented with mechanically coupled pairs of 10-foot rods placed 20 feet deep and spaced 20 feet apart. The first ground rod location can be at the antenna, and the second should be 20 feet away, in the direction of the equipment building and connected to the below grade bare copper wire going to the building perimeter ground loop.

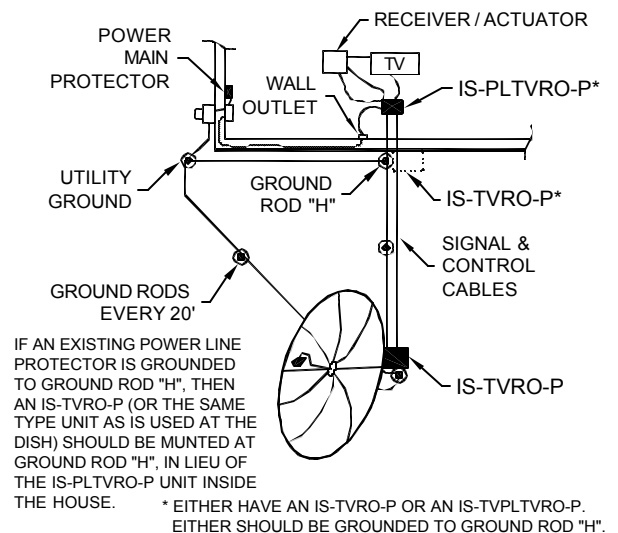

Additional radials should be used to augment the Ufer grounding. RF and control cables for the system should follow the line of grounding rods which are spaced 20 feet apart (**overhead view**).

If the installation is in a rocky area and it is virtually impossible to install ground rods, a radial system may be used. Grounding may be accomplished by laying 10 or more lengths of 10 gauge or larger bare copper wire, at least 50 feet long in a radial fashion connected to and going out from the antenna base, much like the spokes of a wheel.

These may be laid on the surface although it is preferable to bury the wire. The antenna base must be interconnected to the equipment building perimeter ground loop.

In sandy terrain (dry sand), increase the interconnect wire size to #2 AWG or larger copper wire (copper strap may be used), and shorten the distance between the rods to 10 feet.

It is always best to measure the soil conductivity, but it is not essential to strive for a 5 ohm ground system. By using the proper I/O (Input/Output) protectors, the equipment can survive most strikes. A satellite dish system may have the following I/Os: 1) 120Vac power; 2) RF coax cable; 3) dc polarization control; 4) actuator/positioner cable.

The power line can be a two-way street. If a lightning strike occurs away from the system but near a utility pole, it can travel to the equipment. A direct strike to the satellite antenna will cause currents incoming to the equipment, elevating it and exiting to the utility line, causing damage in the process.

A power line protector that plugs into the wall has the equipment power cord series inductance from the equipment to it and also has an even longer safety wire ground run to the distribution panel before it gets to the utility ground rod. The fast rise time pulse of a lightning strike, it is not really grounded at all!

A power mains protector mounted directly to the breaker box across the 240 volt mains to neutral and ground can protect the whole site from incoming surges. A second protector mounted or grounded directly to the equipment chassis will "switch" surge current incoming from the antenna to the antenna system ground and to the perimeter ground loop.

RF CABLE PROTECTION

Surge current will propagate on the coax creating a differential in as little as 15 feet. The center conductor energy differential can damage equipment, inside (receiver) and outside (LNA, LNB, down converter, etc.). A coax protector clamping at the +22 volt level for LNB's with low loss and good VSWR over the 450 to 1450 Mhz range is required. The specifications of the protector will vary based on the type of system being installed.

POLARIZATION CONTROL & ACTUATOR

The polarization rotor or polarity switch is another source of surge current to the equipment. In addition, the actuator or driver must have a protector for the controller and also the motor and switches.

The system will need two sets of protectors, one at the antenna, which is grounded to the antenna ground system, and the other at the equipment building, grounded to the perimeter ground loop.

At this point, protection has been established for the system I/Os, but in the event of a direct strike to the feed, damage can still occur to the LNA/LNB. To help stop direct strikes, take a 10-foot rod and pound it in no more than 6 feet away from the antenna. Couple a second 10-foot rod to extend at least 2 feet above the highest point on the dish. Interconnect the rod assembly to the antenna ground system. This assembly should act as a diverter, sending up a streamer towards a stepped leader, and attracting the strike to itself.

Appendix

Lightning Protection Myths and Traditions

Tables & Formulas

Definition of Terms

Bibliography

Lightning Protection Myths & Traditions

TOWER LIGHTNING DOWN CONDUCTORS

The first myth is adding a lightning rod to a tower and a copper down conductor running the length of the tower and separately connecting to the ground system or one ground rod. The concept is to divert the lightning energy around the tower. Usually the joint resistance between tower sections, averages about 0.001 ohm and will create a voltage drop during a tower strike. The downconductor is to eliminate these resistive drops. However, the strike's inductive voltage drop, for either the copper cable or the tower, far exceeds the resistive voltage drops, and the ground potential elevation at the tower base near the one isolated ground rod, makes it ineffective. The tower inductance is many times smaller than the down conductor's inductance (due to the much larger surface area or skin effect, even with the ferrous effects of the tower steel). The voltage difference between the down conductor, attempting to carry the strike with its large $L \, di/dt$ voltage drop, and the tower will be further increased by the tower induced opposite EMF voltage on the down conductor. This huge voltage difference will be so great it could arc 1.5 feet! Unless the tower and downconductor are separated by this impractical distance, they will be connected by the arc's conductivity, and current will still traverse the tower. The coax cable on the tower has a much larger circumference/lower inductance than the downconductor and is much more effective at "shunting" the tower sections (if that were a concern). The coax cable is also grounded to the tower at the top, *middle*, and bottom.

The proximity of a bare copper downconductor to the tower's vertical legs can be detrimental. Rain

water coming into contact with copper can carry ions that react with the galvanized coating on the tower, causing it to wash off. (Natural rain water—not acid rain—has a pH of +5.5 to 6.0, which is acidic.) Acids will attack copper and with time eat it away. This can decrease the life of the tower (and its safety) as the tower rusts.

Tradition is hard to overcome. In the early days of broadcasting, when medium wave (AM) stations were beginning to operate high-powered transmitters, it was noted that, due to high rf currents on the tower, small arcs were occurring between corroded joints on existing (old) towers. Arcing noise was effecting the transmitted audio. When a continuous downconductor was placed from top to bottom of the tower, the transmitter noise was greatly reduced or went away.

Ship to shore radio communications on low to medium wave frequencies sometimes used insulated (from earth) towers for both transmitting *and receiving*. In some cases the transmit tower and the receiver tower were (in terms of wavelengths) close together. Since communications were on several frequencies at the same time, it was noted there was receive signal degradation that could not be removed by receiver filtering (then). When the same corroded joints on the receiver tower were bypassed by a downconductor, the degrading "noise" was greatly reduced or went away (again). Now radio engineers, being an observant group, noted the improvement and carried the downconductor idea over to new tower site construction. However, the "tower bypass conductor" only shunted the tower sections and did not go to earth ground—it could not with an insulated tower.

Since large downconductors on structural lightning rod installations were standard, and since a grounded tower appears to be a very large lightning rod, “common sense” suggested a large down-conductor on the tower with perhaps a lightning rod on top. The lightning rod would send an “upward going streamer” to connect with the downward step leader from the cloud and “protect” the antenna from a direct strike and subsequent physical damage. This is a good idea if the “lightning rod” is higher than the antenna (and won’t interfere with the antenna’s radiated pattern). A large downconductor, insulated from the tower, would then be routed down in the tower to a separate ground rod or grid. Perhaps, to further isolate the lightning energy from the tower, the lightning rod would be insulated from the tower. Do you think a 4” insulator or an insulated wire would “isolate” a tower from lightning current after the “bolt” has jumped *two miles* to hit you?

Note: If a grounded communications tower were in a multiple frequency, high rf environment, there could be a *slight* chance of rectification or re-radiation of combined rf energy that *might* cause receiver degradation or transmitted spurious. A downconductor could be of some value if the tower joints were questionable.

GROUND RADIAL CIRCLES

Myth: Connect equally spaced ground rods (from the tower base) together to form a circle or concentric circles.

“Radial wires should be interconnected by wire rings.”

If this grounding system were installed at a site with a poor conductivity earth surface layer, the large inductance of the interconnections to the rings will make the rings ineffective. A ground ring will launch electrons mostly outside its circumference. Two closely spaced rings are like two ground rods attempting to couple charge into the same volume of earth. The electrons from each rod are repelled, reducing the effectiveness of the investment in buried copper.

Tradition: “Once again let us return to those golden days of yesteryear” and revisit our broadcast engineer friends. Early MW (AM) broadcast stations were concerned with daytime groundwave propagation to adequately serve their local audience. The radiated “take-off angle” of their transmitted signal had to be as low as possible, so the grounding system under the tower had to capacitively couple to the earth body efficiently. Experimentation to determine optimum grounding system geometry determined that multiple radials outbound from the tower base closely approximated the ideal solid plate capacitive coupling to earth.

As experiments continued, an ideal grounding system model started to emerge. During the experimental phase, our engineers noted that grounding systems approaching the ideal model appeared to lessen lightning damage to transmitting equipment. Radials every 3 degrees (120) extending out the height of the tower, or $\frac{1}{4}$ wave of the operating frequency were determined as optimum. Experiments with concentric wire “rings” with radials were conducted to more closely approximate the ideal flat capacitor plate.

Once again, this observed decline in lightning damage, due to “radials and rings” was carried over to new tower construction. Newer computer-generated tower and grounding models have improved on the original concept and matched the grounding system more closely with coverage area, ground conductivity, and terrain requirements. But ground rings remain as a traditional method even on non-radiating grounded towers. The real answer is multiple radials with ground rods (see chapter 2).

NOTHING WILL SAVE YOU

Nothing will save the equipment if the tower takes a direct strike. This myth came from those who did not install a proper grounding system. It is difficult to allocate additional funds for the materials and labor needed to include a good grounding system when a new site is under development. Often the lowest bidder gets the job erecting the tower. Unless a specified grounding plan is written

in the bid package, the bare minimum is quoted or grounding is omitted altogether. Those who think that three eight-foot rods around the tower base is a good grounding system are on the right track only if the tower will be erected on the beach at high tide.

Even with planning, no one can say if an installation will or will not survive, since the intensity of a hit is a variable. It is safe to say that less damage (if any) will be sustained with a properly grounded tower.

TO GROUND OR NOT TO GROUND

One of the best sayings is really not a myth at all. "A grounded tower is more likely to be hit." As we saw in the graph in chapter one, the taller the object the more frequently it's struck. Why ground a tower if it means that it is more apt to be hit? Look at it from the reverse point of view—a tower that isn't grounded and is hit will send energy out any available path towards a lower potential. The equipment could be the path of choice. If the tower is properly grounded, the owner has control. The whole concept of lightning protection is to control and direct the lightning surge energy so it does the least amount of harm or damage.

ELECTROSTATIC DISSIPATION DEVICES

Some people think if you have many sharp points around a tall object, it will give off enough ions to enshroud the object and eliminate lightning strikes. If this were true, towers with many antennas, or trees in a forest, would never be hit! Trees are not a good conductor. But with the very high impedance of static E fields, they do conduct, since lightning does hit them. Whether due to a mountain, building, or tower height, strike occurrence goes up as the square of height over average terrain. Brushes or static dissipation devices will not prevent a strike.

One of the selling "points" for wire brushes is they reduce the electrostatic voltage between the cloud's charge center and the site. This is indicated

as being done with a grounding system that reduces the induced electrostatic voltage in the ground by the brush creating ions, blown away by the wind. This would be a great idea, but the ground can provide the induced voltage faster than the brush can create ions. Imagine the site as a three dimensional object in free space. The site's surface area has an ability to store a charge. The brush (or a few sharp points) can create a current, in an E field of 10kV/m, of about 0.5A. This is a 20k ohm load. The R×C time constant of this discharge, compared to the site ground (typically 5 ohms), is (20k/0.5 = 4000) 4000 times faster! This means the earth (with a 5 Ohm grounding system) can provide electrostatically induced voltage to the tower 4000 times faster than the brush can dissipate it!

Wind blown ions will not cancel the earth/cloud charge and prevent a strike from happening. If no wind is present the ion space charge will drift upwards. The ions make the air *more conductive* and can help direct the stepped leader (precursor to the strike) to the brush resulting in an upward going streamer (return stroke). Brushes will not stop the formation of upward going streamers, although they may slightly delay it. They may help stop corona from a sharp object under lab conditions, but under real site conditions they are not effective. We simulated a strike to a dissipation brush with our largest surge generator and found that when struck, the brush explodes in spray of molten steel creating a fire hazard for any structure below.

Those who sell this kind of product claim many happy customers with no equipment damage. Only those who do not have a good grounding system would buy such devices. When they are installed, a good grounding system is always included with the installation. The good grounding system is what reduces damage! A US Navy report, done in cooperation with the USAF, NOAA, and the FAA, states that after several years of study, dissipation devices have not prevented any lightning strikes (if they worked, NASA would be using them extensively). The FAA did another study and has video tapes showing them being hit (again).

The myth we want to hear: “We don’t know if all the money we spent for lightning protection was worth it. We haven’t been hit yet!” How does one know that a strike has not occurred? (PolyPhaser has a line of strike counters.) Undamaged equipment is not a true indicator. It only takes one strike. If lightning protection was installed, then “no news is good news.”

Water & Soil Resistivities

<u>Type of Water or Soil</u>	<u>Resistivity in Ohms</u>
Water in oceans	0.1 - 5
Ground water, well and spring water	10 - 150
Lake and river water	100 - 400
Rain water	800 - 1,300
Commercial distilled water	1,000 - 4,000
Chemically clean water	250,000+
Clay	25 - 70
Sandy clay	40 - 300
Peat, marsh soil and cultivated soil	50 - 250
Sand	1,000 - 3,000
Glacier	3,000 - 10,000

Formulas

MULTI-CHANNEL COMBINING

Combining consists of summing multiple channels together to feed onto a common cable. Low frequencies and higher frequencies will in time reach a peak voltage together of the same polarity. This voltage summation peak can have more peak power than the sum of their RMS powers. Since gas tube protectors are voltage sensitive, they must be designed to handle combiner outputs or turn-on RF voltage peaks can result. This can cause major problems at other frequencies (intermod, spurs, interference, etc.). Each protector designed for combiners is listed as to its total voltage peak (VT) that it can handle without RF turn-on. This total is the summation of all the voltage peaks for each channel being combined.

$$V_T = V_{P1} + V_{P2} + V_{P3} \dots + V_{Pn}$$

where $V_p = 1.414 \cdot X \cdot \sqrt{P_{ch} \cdot 50}$

(P_{ch} = channel power out of combiner)

and for a	VSWR	X =
	1.1 to 1	1.05
	1.2 to 1	1.09
	1.3 to 1	1.13
	1.4 to 1	1.17
	1.5 to 1	1.2
	1.86 to 1	1.3

CALCULATING INDUCTANCE:

Copper Wire:

$$L(\text{in } \mu\text{H}) = 0.508l [2.303 \log_{10} (4l/d) - 0.75] \times 10^{-2}$$

Copper Strap:

$$L(\text{in } \mu\text{H}) = 0.508l [2.303 \log_{10} (2l/(w + t)) + 0.5 + 0.2235 (w + t)/l] \times 10^{-2}$$

Where: l = length in inches
 d = diameter in inches
 w = width in inches
 t = thickness in inches

IS-158E & 318E HIGH POWER GAS TUBE SELECTION:

$$V_p = 1.414 \cdot X \cdot \sqrt{P_{ch} \cdot 50}$$

V_p = Voltage peak

P_{ch} = Power per channel

X = VSWR (same as Multi-Channel Combining)

Definition of Terms

AMPERE

An ampere (current) is a (coulomb/second).

BANDWIDTH

Difference in frequency between the upper and lower 3dB down response frequencies.

BI-PHASE

Found as a power feed to most U.S. homes. Derived from a center tapped transformer, it contains two hot phases (180°) with a center tap neutral return. Normally supplied as two 120 volt single phases with 240 volts available across both phases. The neutral return is usually earth grounded.

CAPACITANCE

Measured at 1.0kHz unless otherwise stated.

CLAMP

To clip. To hold turn-on voltage as current is increased. Turn-on voltage is the same, or nearly the same, as "on" voltage drop.

CLAMPING RATIO

The ratio of voltage drop at a given current to the turn-on voltage.

CLAMPING SPEED

Measured with full lead length using a 1kV/ns waveform in a 50Ω system, with $\geq 300\text{MHz}$ or larger bandwidth.

COMBINER

The summation of multiple transmitters into one transmission line. The peak voltage from each signal will be additive and will be higher than the sum of the power would indicate.

COMMON-MODE

Pertaining to signals or signal components referenced to ground.

COULOMB

Measurement of charge. Often used to indicate the amount of transferred charge through a gas tube to determine gas tube life. "Q" abbreviation. A coulomb is (current x time).

CROWBAR

To turn-on and clamp close to ground level. Having a high turn-on trigger voltage and a low "on" voltage.

DIFFERENTIAL MODE

Referenced only between conductors (not referenced to ground).

DIPLEXER

(TV Broadcasting). The combining of two transmitters into one transmission line. TV visual and aural.

DUPLEXER

Simultaneous receive and transmit on one transmission line. Where a T connector splits/combines the signals to two groups of filters. The receiver filter passes the receive frequency while rejecting (band stop) the transmitter's frequency. The transmitter filter passes its frequency while attenuating the Class C transmit noise at the receive frequency.

EMI/RFI

Electro Magnetic Interference/Radio Frequency Interference. Broad spectrum noise or interfering signals.

EMP

Electro Magnetic Pulse, usually referred to as the man-made generation by detonation of a nuclear bomb at a high altitude, which generates a very fast pulse (RF) which can be captured by antennas and long unshielded lines. Sometimes referred to as NEMP, HEMP, etc. Lightning can also generate an EMP near the event. Referred to as LEMP.

EMP RATED

Rated as having a fast enough turn-on time or filtering to protect against the effects of an EMP event.

FARADAY SHIELD

An electrostatic (E field) shield made up of a conductive or partially conductive material or grid. A Faraday cage or screen room is effective for protecting inside equipment from outside radiated RF energies.

FILTERING (EMI/RFI)

Measured in a 50Ω system — loaded. As per MIL-STD-220.

FREQUENCY RANGE

The bandwidth over which both the listed maximum VSWR and Insertion Loss specifications are valid.

GROUND IMPEDANCE

The ground resistance and the inductance/capacitance value of the grounding system. Also called dynamic surge ground impedance.

GROUND LOOP

An undesired potential EMI condition formed when two or more pieces of equipment are interconnected and earthed for shock safety hazard prevention purposes.

GROUND RESISTANCE

The resistance value of a given ground rod or grounding system as measured, usually by a fall of potential (3 stake) method, using a 100Hz signal source.

HF

High Frequency – normally from 3 to 30MHz.

HOUSED USE ONLY

For indoor use, or must be further enclosed or rain-proofed for outdoor usage.

IMPEDANCE

Nominal impedance of the device. The variation of this impedance with frequency is measured as VSWR.

IN-LINE

Power or signal passage through unit. In series with line. Usually a multi-stage protector. Best protection method.

INSERTION LOSS

Loss of a device across the stated frequency range. This type of loss is due to the insertion of the unit in series with a signal path.

JOULES

A unit of energy. One joule for one second is equal to one watt of power. Joules is (current x time x voltage).

LEAKAGE CURRENT

Usually measured at 50 or 60Hz with 120, 240 or 480 volts ac. However, it can be ac or dc at a specific voltage and frequency.

LOOP RESISTANCE

Total resistance as measured across the input with the output shorted.

MAXIMUM PEAK LET-THROUGH VOLTAGE

Measured at a given surge current using a given waveform, and using $\geq 300\text{MHz}$ bandwidth across a 50Ω impedance. (Note: this 50Ω impedance may be dc blocked [large bandwidth compared to the surge frequencies present] and 50Ω resistive load [termination]).

MAXIMUM POWER

Maximum Continuous Wave (CW) transmit power, without unit degradation.

MAXIMUM SURGE

The maximum single surge current and specified waveform that can be handled by a device without failure during the conduction of that waveform and which ends the life of the device for conducting successive waveforms, but does not allow any generation of outward projectiles.

MULTI-STRIKE CAPABILITY

In most applications current sharing will occur, and in a direct strike event the unit will survive to work again.

POWER

Power is (voltage x current) or a (coulomb/second).

RECEIVER MULTICOUPLER

Sometimes with an amplifier, this device has one antenna line and multiple outlets.

RF

Radio Frequencies — any and all frequencies that can be radiated as an electromagnetic wave (plane wave).

SAFETY GROUND

The local earth ground. The earth ground which grounds the neutral return. The wire may be green or bare and can be through a metal conduit. It may be earth grounded as many times as needed. (Neutral must only be grounded once at the entry location).

SHF

Super High Frequency – from 3000MHz to 30GHz.

SHUNT PROTECTOR

Line-to-ground. No power or signal passage through unit. Not in-series with line.

SINGLE PHASE

A true single phase supply. Usually a two-wire system with one hot phase and a neutral return. A safety earth ground is also present.

SKIN EFFECT

The gradient conduction and propagation of RF or RF components of a surge on the outer surfaces of conductors.

TEMPERATURE

The extremes of operating or storage that the unit or unit parts have been tested to under MIL-STD-202 for thermal shock.

THREE PHASE

It consists of sinusoids 120° apart on at least three wires (Delta) and often four wires (Wye). The fourth wire is a grounded neutral return. In a Delta system there is no reference to ground and thus it is more susceptible to lightning problems.

THROUGHPUT ENERGY

The total energy that will be let through the device using the indicated surge waveform.

TOTAL SURGE ENERGY

Total sum of surge energy for all lines of a protector unit. Measured in joules. The minimum total energy which results in the failure of the unit.

TRANSFER IMPEDANCE

Referring to coax, is the impedance to transfer into or outside the coax at various frequencies usually below 1MHz. Due to loss of skin effect attenuation or shielding at these low frequencies, coax can be susceptible to interference and noise as well as the radiation of such signals.

TURN-ON TIME – GAS TUBE

The amount of time that exists in the period that occurs when the ramp voltage barely exceeds the turn-on voltage of the device, and the point at which 50% of the peak voltage is achieved during the turn-on (crowbar) process. Measured in a 50Ω system with ≥ 300 MHz bandwidth.

TURN-ON Vac

The maximum ac sine wave voltage that can be passed with the peaks just at the turn-on Vdc level.

TURN-ON Vdc

Turn-on voltage at 1mA dc with a ramp of 100V/ms typical.

UHF

Ultra-High Frequency – normally from 300 to 3000MHz, however in this catalog we breakout 800 to 1000MHz separately even though it is within this category.

VHF

Very High Frequency – from 30 to 300MHz.

VLF

Very Low Frequency – from 300Hz to 3kHz.

VOLT

A volt is a (joule/coulomb).

VSWR

Voltage Standing Wave Ratio (VSWR) of the device across the stated frequency range. VSWR is the amount of reflected signal due to an impedance mismatch.

VT MAX

The max peak voltage of all combined waveforms. V_{total} is used for multi-coupled or combined transmit signals.

Bibliography & Further Reading

- (1) Decible Products Inc. [About Lightning](#)
- (2) Block, Roger R. [The "Grounds" for Lightning & EMP Protection](#).
- (3) Eaton, J.R. "Impulse Characteristics of Electrical Connections to the Earth." [General Electric Review](#), October 1944.
- (4) Fagan, E.J. and Lee, R.H. "The Use of Concrete Encased Reinforcing Rods As Grounding Electrodes. [IEEE Transactions On IGA](#), July/August 1970.
- (5) Freeman and Sachs. *Electromagnetic Compatibility Design Guide*. Sachs/Freeman Assoc. Inc., 1981.
- (6) IEEE Transactions On Broadcasting. Vol. BC-25, No 1, March 1979.
- (7) IEEE/ANSI C62.41 – 1991 Recommended Practice on Surge Voltages in Low-Voltage AC Power Circuits
- (8) Lightning Protection, Code [NFPA 780](#).
- (9) Military Handbook 419A, [Grounding, Bonding, and Shielding for Electronic Equipment and Facilities](#)
- (10) Schure, Alexander. [Electrostatics](#), New York: John F. Rider, June 1958.
- (11) Towne. Lightning Arrestor Grounds. [G.E. Review, 1932](#).
- (12) Ufer, H.G. "Investigation and Testing of Footing Type Grounding Electrodes for Electrical Installations" [IEEE Transactions Paper #63-1505, Power Apparatus Systems Vol. 83 pp 1042-1048: Oct. 1964](#).
- (13) Uman, Martin A. "[All About Lightning](#)" and "[Lightning](#)," New York: Dover Publications, 1986,1984.
- (14) Viemeister, Peter E. [The Lightning Book](#). Cambridge: The MIT Press, April 1972.
- (15) Weiner, Paul. "A Comparison of Concrete Encased Grounding Electrodes to Driven Ground Rods". [IEEE I&CPS Conference](#). May 1969.

Please check out our web site (www.PolyPhaser.com) for informative links on lightning.



NOTES